

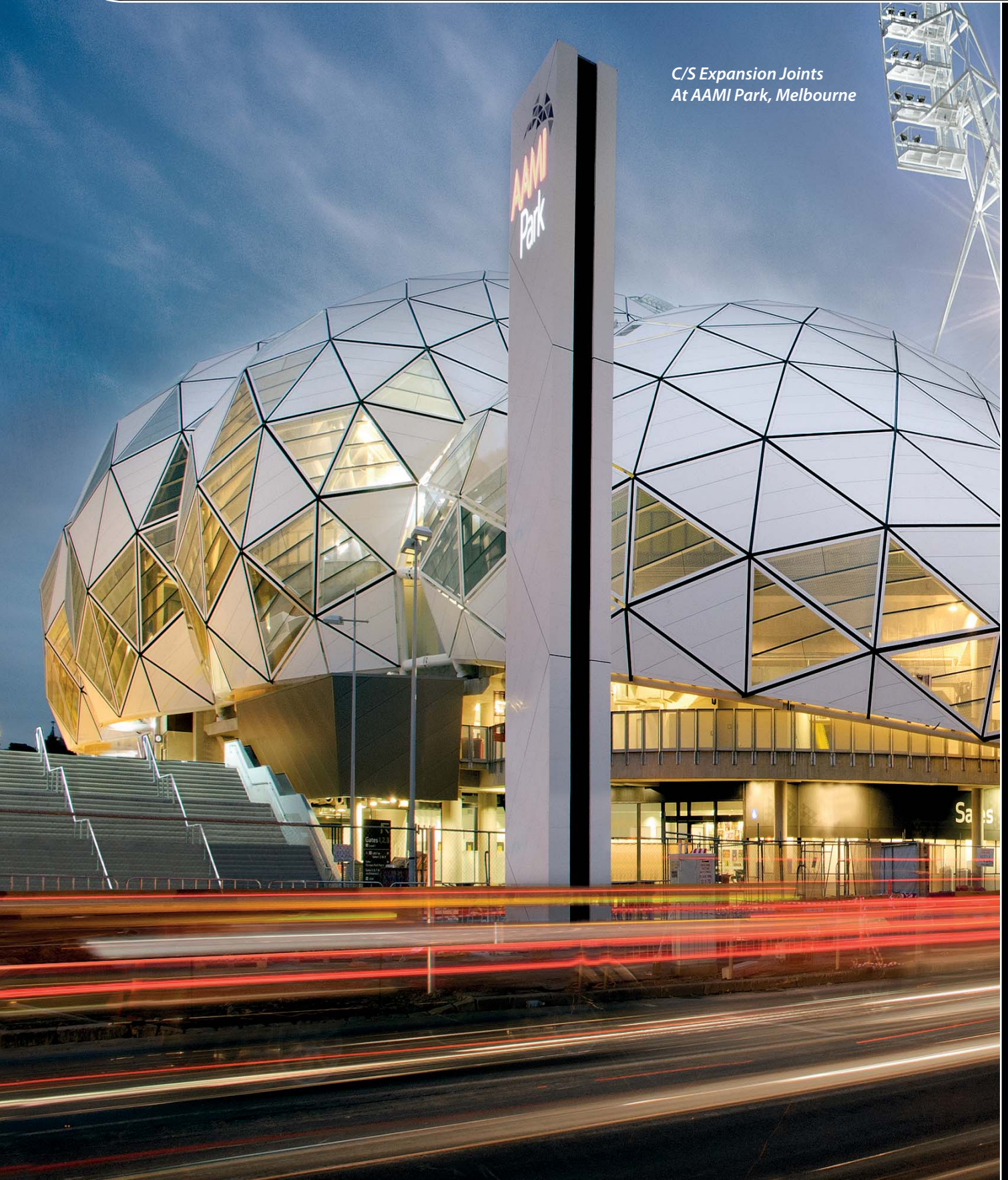

Expansion Joint Covers *Providing unique solutions to complex building problems for over 60 years.*

*C/S Expansion Joints
At AAMI Park, Melbourne*





SSR Series Floor Cover

The introduction of a corrugated extruded aluminum center plate provided weight reduction, superior strength and mechanical fastening of the side pans (no welding). The introduction of low friction bearings removed any metal-to-metal contact and allowed for friction free operation. Finally, a gravity based turnbar assembly removes the need for a spring.



*Fiona Stanley Hospital
Architects: Silver Thomas Hanley
and Hassell Architects*

C / S EXPANSION JOINT COVERS

All Expansion Joints are not created equal!

XLS Exterior Wall Cover

This cover was originally designed for the international terminal at San Francisco Airport to allow the large seismic joints to be concealed within the cladding. The key to this system is the innovative gravity closing system that automatically reseals the cover after a seismic event. The cover will receive a wide variety of cladding systems including metal, glass and stone.



*Valley Presbyterian Hospital
Architect: Lee Burkhart and Liu*



LAF Series Wall Cover

Following the damage review after the Northridge quake, C/S designed a wall cover that disengages in a seismic event (tethered to prevent falling) to protect the surrounding finishes damage.



*Kaiser Permanente
Downey Medical Center
Architect: HMC Architects*

On the surface most expansion and seismic joint covers may look the same, which is why it's important that you look a little deeper. As the originators of most of today's cover technology C/S has had to deal with many imitators—it may be flattering but it doesn't make them equal!

APF Series Floor Covers

Based on a European design used successfully for 20 years, this robust all-aluminum cover presents a remarkable flush finish offering zero resistance to heavy rolling loads. This system is perfect for airports, public buildings and manufacturing facilities.



*Royal Children's Hospital Melbourne
Architect: Bates Smart and Billard Lease*

Having the best products is only the start, how we apply them is the key!



The Oakland Diocese's initial project prospectus called for light as the central focus of the design, and they asked the design team to create a timeless structure capable of enduring for three centuries. SOM's design for the sanctuary features two interlocking spherical grids in the form of the "Vesica Pisces," the conjoined circles that represent both an ancient symbol of congregation and the basic symbol of Christianity—the fish. The entry vestibule acts as the fish's tail. The soaring Cathedral has glue laminated Douglas fir ribs that vault from a pair of poured-in-place slag walls and high performance, fritted, curved glass walls. The result is a glowing, indirectly lit interior space, vaulting 12 stories to a glass oculus roof.

The 410mm base isolation gap around the entire perimeter could have been a huge barrier to achieving this stunning design. Working with the architect in the early design phase, C/S technicians successfully integrated the seismic cover system into the original design concept.

Flush unobstructed finish allows entry to the magnificent cathedral.

The cover system was corded to sympathize with the spherical design concept.

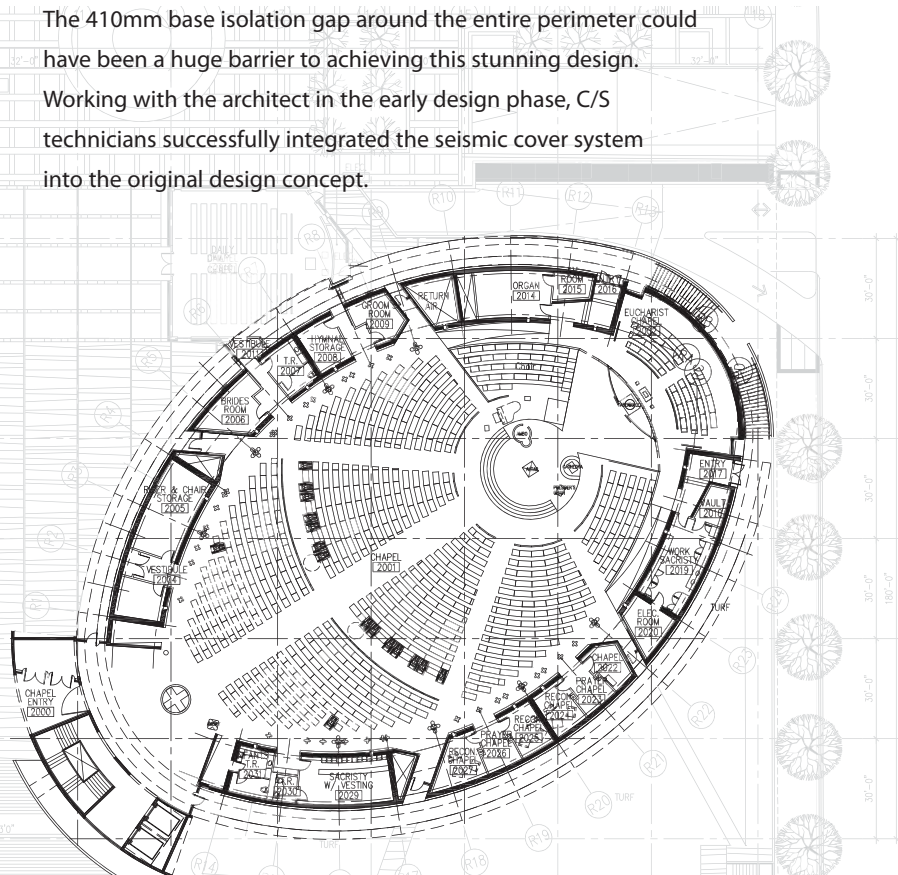

The award winning Cathedral of Christ the Light project in Oakland, California by Skidmore Owings Merrill was designed as an abstract modern form that functions as both a church and civic structure.

Design Architect: SOM
Architect of Record:
Kendall/Heaton Associates



To withstand potentially devastating seismic activity, SOM isolated the Cathedral's superstructure from its foundation using Friction Pendulum Bearings and also created a moat around the structures' exterior walls to allow for significant lateral movement. **SOM specified 410mm C/S SSRW Expansion Joint Covers to conceal the moat.** The C/S SSRW Covers are also installed in the building's entry vestibule, separating it from the main building. All of the SSRW covers provide four-way movement and work in conjunction with the base isolators to provide the building up to 760mm of movement in any horizontal direction and up to 100mm of vertical lift.

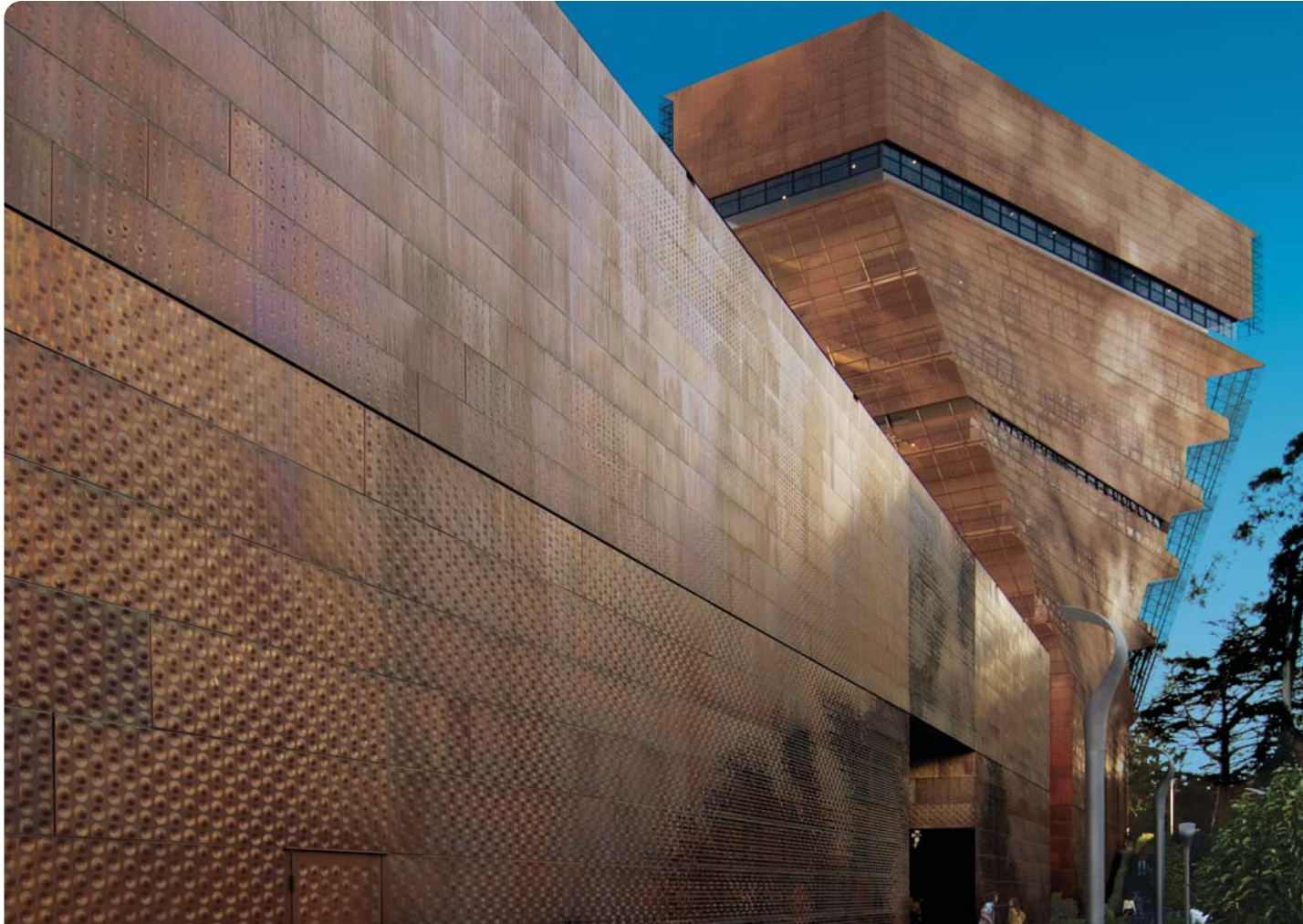

The Art of Concealment

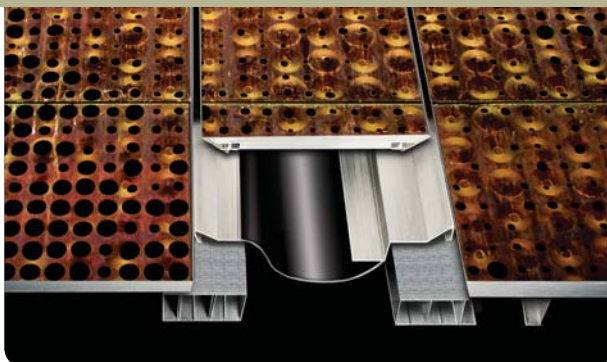

C/S at de Young Museum

A major consideration of the de Young project was that the expansion joint covers must be “virtually invisible” within the museum’s weathered copper skin. Architects Fong & Chan, SF, and Herzog & de Meuron specified CS’ XLS cover system knowing it could be seamlessly incorporated into the facade’s copper panel frame. The 610mm XLS covers are designed to release from the wall to provide full seismic movement.



Large seismic joints are a necessary evil in today's architecture and can destroy even the finest facade design. C/S has become a master at the art of concealment, developing a range of covers that truly empathize with an architect's design intent.



C/S at Orange County Performing Arts Center



In the interior of the magnificent Segerstrom Concert Hall, Architect Pelli Clarke Pelli specified C/S 305mm LAF Seismic Wall Covers. Virtually imperceptible, the LAF wall covers are lightweight, match the concert hall's wall finish without visual interruption and provide full movement of the joint without damage to surrounding wall surfaces.

Selection Chart

Floor Covers

The size of joint and movement dynamics dictate whether you require a standard or seismic expansion joint cover system. Before making a selection, there are other decisions you must make. The selection of the floor cover is often the most critical step in the

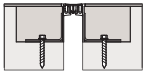
specification process since the performance of the floor cover has the greatest impact on the occupants of the building. The presence of rolling loads and the need for hygiene are major considerations in cover selection, while aesthetics in seismic covers is also a significant issue.

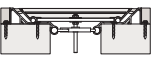
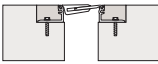
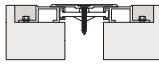
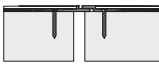



Cover Type	Flush Thinline Gasketed	Flush Twinline Dual Gasketed	Flush Seismic, Seismic Pan	Standard Allway Metal	Allway Metal	Aluminium Minimal Movement
Product Name	GFT/P	GTR/P & SGR/P	SSR	APF & ALS/R	SJP & KLP	AMV3/CSFM
Appearance						
Joint Size	25mm and 51mm	51mm to 102mm	102mm and up	25mm to 150mm	25mm and 50mm	5mm to 12mm
Description	Minimum exposed surface, sealed dual durometer gasket installation	Minimum exposed surface, sealed dual durometer gasket installation, larger movement	Minimum exposed surface, optional sealed gasket installation, seismic movement	Robust applications, low maintenance	Robust applications, low maintenance	Minimum exposed surface, low maintenance, small movement
Finishes	Carpet, vinyl, ceramic tile, terrazzo, stone	Carpet, vinyl	Terrazo, stone Vinyl	Concrete, carpet, vinyl	Concrete, pavers, carpet, vinyl, ceramic tile	Carpet, vinyl
Designed For	Hygienic, wheeled equipment	Hygienic, wheeled equipment	Hygienic, wheeled equipment, deep floor finish materials, also exterior	Industrial, heavy wheeled equipment	Commercial and heavy foot traffic areas	Commercial interiors
% Movement +/-	25% Of Joint Width	50% Of Joint Width	50-100% Of Joint Width	50-100% Of Joint Width	50-100% Of Joint Width	50% Of 10mm Joint Width
Page #	10-11	12-15	16-17	18-19	20-22	23

Wall & Ceiling Covers

Having selected the floor cover, identifying a matching wall cover is a relatively simple task. When it comes to seismic covers, however, there are options driven by both functionality and aesthetics. Choose from covers that become detached from the wall to minimize damage or ones that are self-closing to minimize post-event maintenance. Many of our wall covers are designed to accept a range of surface materials to maximize concealment of the cover.

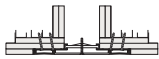
Specialty Covers

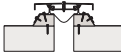
Specialty covers, such as roof covers and vehicular joint systems, are available for most joint sizes and movement dynamics.

Flush Thinline Gasketed	Flush Twinline Dual Gasketed	Allway Metal	Exterior Wall	Roof	Parking & Stadiums	Road/Parking
FWF, FCF, FWS, FCS	GTW, LAF, SGW, SGC	AFW, ASM, HC	SF, SC, VF, XLS, ESW/C	SRJ, BRJ	ZB	CSX
						
25mm to 102mm	51mm and up	25mm to 102mm	51mm and up	51mm and up	25mm to 406mm	19mm and up
Minimum exposed surface, sealed gasket installation	Minimum exposed surface, sealed gasket installation, larger movement	Robust applications, low maintenance, full movement range	Minimum exposed surface, sealed gasket installation, full movement range	Formed aluminum and EPDM bellows options, full movement range	Exterior, waterproof applications, full movement range	Minimum exposed surface, preformed, flexible and UV stable
Drywall, ceramic tile	Drywall, ceramic tile	All finishes	All finishes	All roof finishes	Concrete, paver	Concrete
Hygienic, matches Thinline floor covers	Hygienic, matches Twinline floor covers	Industrial, matches Allway floor covers	All exteriors, colorable	All roofs	Vehicular traffic, stadium seating bowls and concourse	Parking structures, bridges, warm climates
25-100% Of Joint Width	50-100% Of Joint Width	50-100% Of Joint Width	50-100% Of Joint Width	50-100% Of Joint Width	25-100% Of Joint Width	50% Compression 25% Tension
24-25	26-27	28-29	30-33	34-35	36-37	37



Flush Thinline Floor Covers 25mm-50mm

Use this cover for:

- Applications with small, interior joints where minimal visual impact is preferred.
- Suitable for most floor finishes. Frame depth and configuration is variable to suit selected finish.
- Where wheeled equipment is to be used.
- Where hygiene is important.

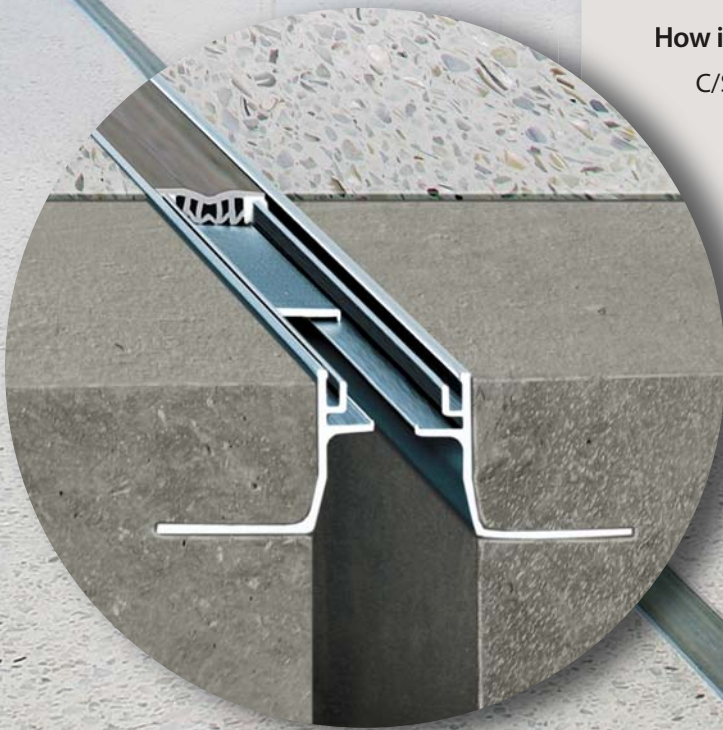

How it works:

C/S unobtrusive, Flush Thinline Floor Covers incorporate a single dual durometer gasket that's designed to expand or compress to accommodate thermal movement. The 25mm models include an aluminium support plate for added durability.

For comprehensive information on these products, visit www.c-sgroup.com.au

Floor Covers

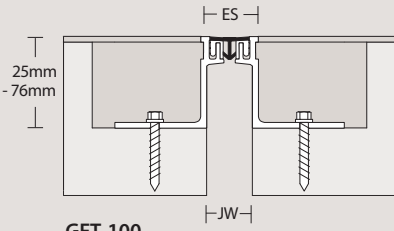

GFT-100

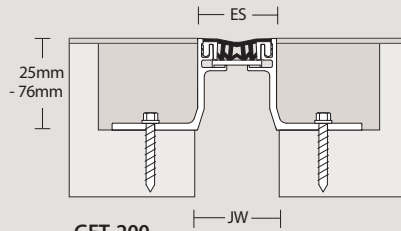

GFT-200

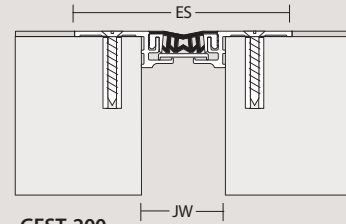

GFST-200

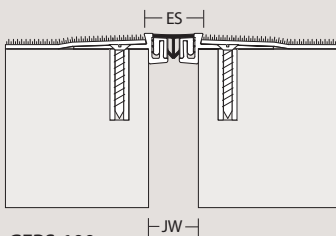

GFPS-100

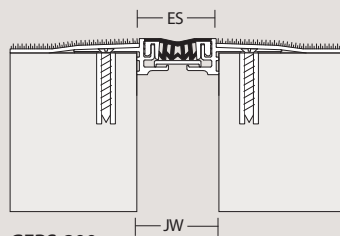

GFPS-200

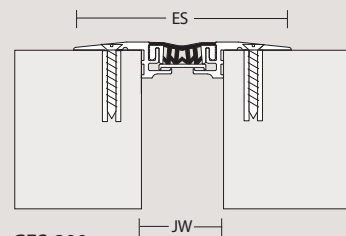

GFS-200

Floor to Wall Covers

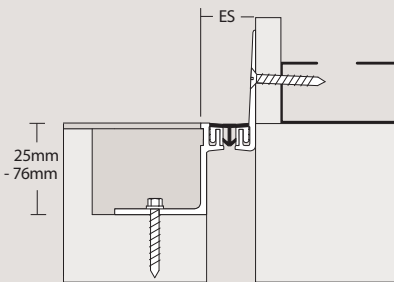

GFTW-100

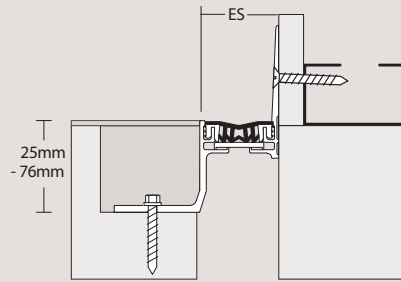

GFTW-200



Dual Durometer

- Harder materials for stronger more secure attachment to aluminum extrusions
- Softer material used to allow for thermal movements

Gasket Colours

Black

White

Grey

Greige

Note: Custom colours available. Call 1300 272 602

Model Data Floor to Floor Covers

JOINT WIDTH (JW)	25.4mm	50.8mm	25.4mm	50.8mm	25.4mm	50.8mm	25.4mm	50.8mm
MINIMUM OPENING	19.1mm	38.1mm	19.1mm	38.1mm	19.1mm	38.1mm	19.1mm	38.1mm
MAXIMUM OPENING	31.8mm	63.5mm	31.8mm	63.5mm	31.8mm	63.5mm	31.8mm	63.5mm
EXPOSED SURFACE (ES)	31.8mm	47.8mm	30.0mm	47.8mm	109.5mm	130.3mm	109.5mm	130.3mm
SPECIFY MODEL	GFT 100	GFT 200	GFPS 100	GFPS 200	GFS 100	GFS 200	GFST 100	GFST 200

Model Data Floor to Wall Covers

JOINT WIDTH (JW)	25.4mm	50.8mm	25.4mm	50.8mm	25.4mm	50.8mm	25.4mm	50.8mm
MINIMUM OPENING	19.1mm	38.1mm	19.1mm	38.1mm	19.1mm	38.1mm	19.1mm	38.1mm
MAXIMUM OPENING	31.8mm	63.5mm	31.8mm	63.5mm	31.8mm	63.5mm	31.8mm	63.5mm
EXPOSED SURFACE (ES)	28.5mm	47.8mm	30.0mm	47.8mm	66.8mm	90.4mm	66.8mm	90.4mm
SPECIFY MODEL	GFTW 100	GFTW 200	GFPSW 100	GFPSW 200	GFSW 100	GFSW 200	GFSTW 100	GFSTW 200

For odd and larger sized joints, call 1300 272 602 or visit www.c-sgroup.com.au

Flush Twinline Floor Covers 50mm - 100mm

Use this cover for:

- Applications with larger thermal movement requirements and where a flush, concealed cover is preferred.
- Applications using carpet or vinyl floor covering up to 3mm deep.
- 10mm Recessed centre plate available.
- Where wheeled equipment is expected.
- Where hygiene is important.

How it works:

Our Flush Twinline Floor Covers include dual durometer gaskets that allow for greater expansion and contraction during thermal movement. A rugged aluminium centre plate that can be concealed spans the joint opening.

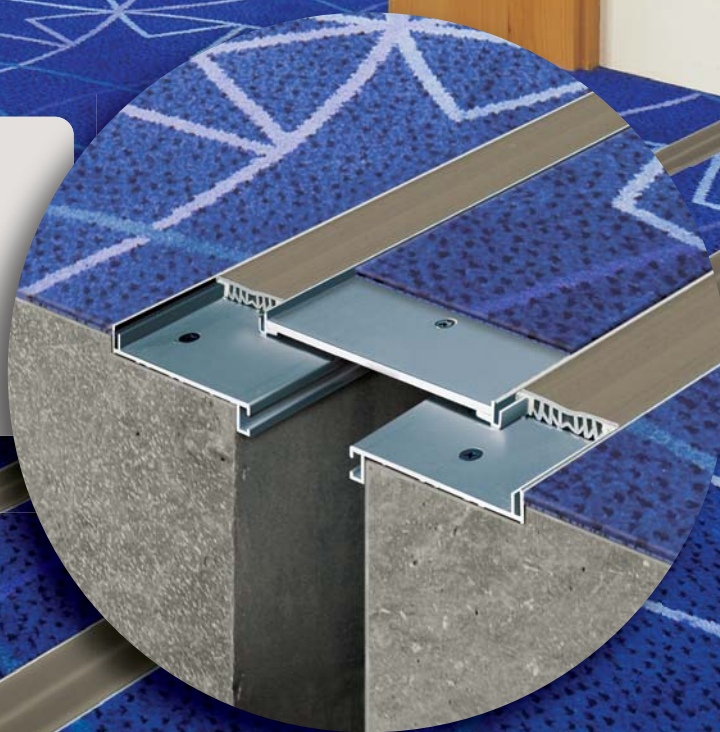

For comprehensive information on these products, visit www.c-sgroup.com.au

Floor Covers

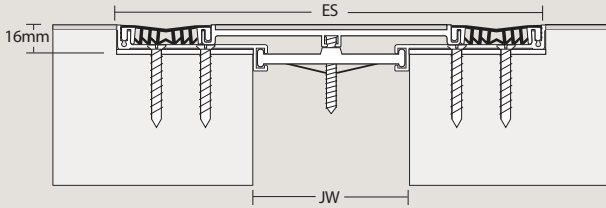

GTR

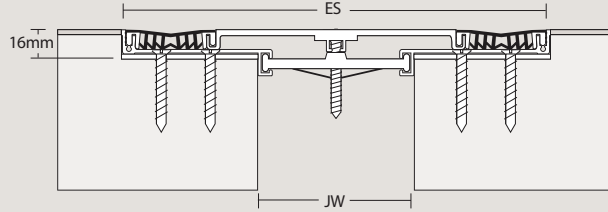

GTP

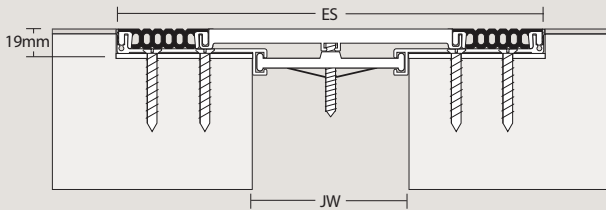

GTP-HD
Heavy Duty 907Kg. Point Load

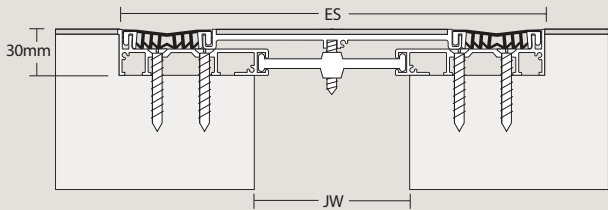

DGTR

Floor to Wall Covers

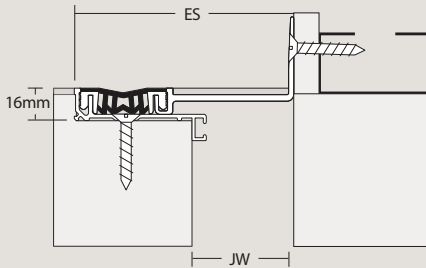

GTRW

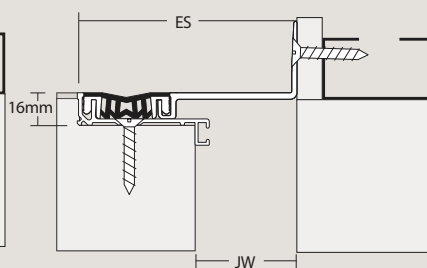

GTPW

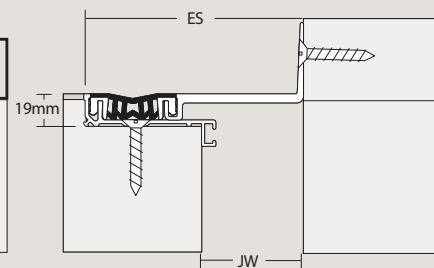

GTPW-HD
(Heavy Duty)

Gasket Colours

Black

White

Grey

Greige

Note: Custom colours available. Call 1300 272 602.

Model Data Floor to Floor Covers

JOINT WIDTH (JW)	50.8mm	76.2mm	101.6mm	50.8mm	76.2mm	101.6mm	50.8mm	76.2mm	101.6mm
MINIMUM OPENING	31.8mm	31.8mm	57.2mm	31.8mm	31.8mm	31.8mm	31.8mm	31.8mm	31.8mm
MAXIMUM OPENING	88.9mm	152.4mm	158.8mm	95.3mm	152.4mm	158.8mm	95.3mm	152.4mm	158.8mm
EXPOSED SURFACE (ES)	165.1mm	254.0mm	279.4mm	165.1mm	254.0mm	279.4mm	165.1mm	254.0mm	279.4mm
SPECIFY MODEL	GTR 200	GTR 300	GTR 400	GTP-HD 200	GTP-HD 300	GTP-HD 400	GTP 200	GTP 300	GTP 400

Model Data Floor to Wall Covers

JOINT WIDTH (JW)	50.8mm	76.2mm	101.6mm	50.8mm	76.2mm	101.6mm	50.8mm	76.2mm	101.6mm
MINIMUM OPENING	25.4mm	38.1mm	63.5mm	25.4mm	38.1mm	63.5mm	25.4mm	38.1mm	63.5mm
MAXIMUM OPENING	76.2mm	114.3mm	139.7mm	76.2mm	114.3mm	139.7mm	76.2mm	114.3mm	139.7mm
EXPOSED SURFACE (ES)	108.0mm	165.1mm	190.5mm	108.0mm	165.1mm	190.5mm	108.0mm	165.1mm	190.5mm
SPECIFY MODEL	GTRW 200	GTRW 300	GTRW 400	GTPW-HD 200	GTPW-HD 300	GTPW-HD 400	GTPW 200	GTPW 300	GTPW 400

GTR and DGTR have same model data. For odd and larger sized joints, call 1300 272 602 or visit www.c-sgroup.com.au

Flush Seismic Floor Covers 125mm - Up

Use this cover for:

- Seismic interior applications requiring a completely flush joint cover virtually concealed in the surrounding floor finishes.
- Applications using carpet or vinyl floor covering up to 3mm deep. (Can be modified up to 5mm)
- Where wheeled equipment is expected.
- Where hygiene is important.

How it works:

Our Flush Twinline Floor Covers include dual durometer gaskets that allow for greater expansion and contraction during thermal movement. A rugged aluminum centre plate that can be concealed spans the joint opening.



For comprehensive information on these products, visit www.c-sgroup.com.au

Cycling

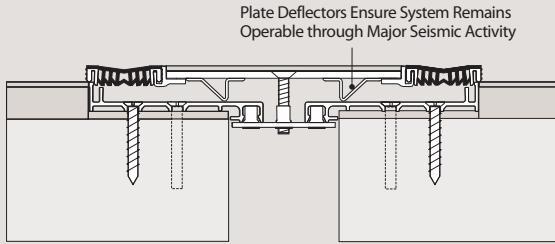

SGR Contracted

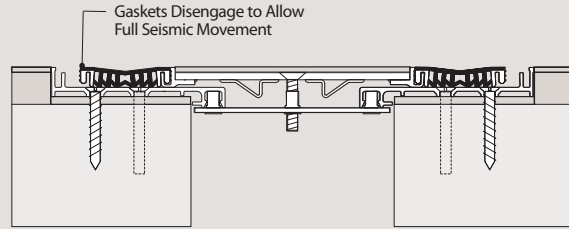

SGR Expanded

Floor Covers

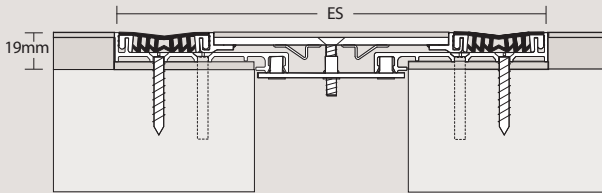

SGR*

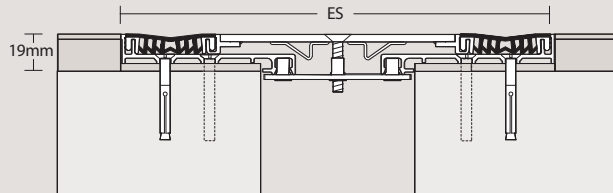

SGP*

Floor to Wall Covers

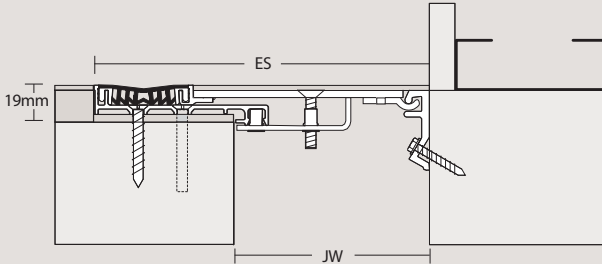

SGRW

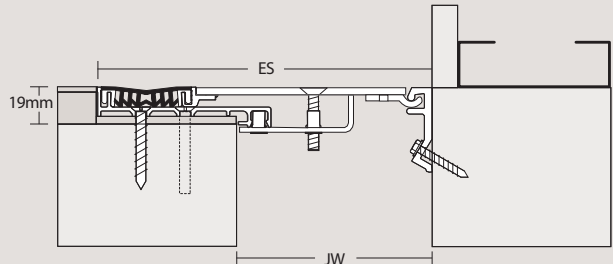

SGPW

Gasket Colours

Black
 White
 Grey
 Greige

Note: Custom colours available. 1300 272 602.

Model Data Floor to Floor Covers

JOINT WIDTH (JW)	127.0mm	152.4mm	177.8mm	203.2mm	228.6mm	254.0mm	279.4mm	304.8mm	330.2mm	355.6mm	381.0mm	406.4mm
MINIMUM OPENING	63.5mm	69.9mm	69.9mm	69.9mm	69.9mm	69.9mm	69.9mm	69.9mm	69.9mm	69.9mm	69.9mm	69.9mm
MAXIMUM OPENING	235.0mm	241.3mm	311.2mm	336.6mm	362.0mm	412.8mm	463.6mm	469.9mm	539.8mm	565.2mm	584.2mm	641.4mm
EXPOSED SURFACE (ES)	304.8mm	330.2mm	381.0mm	406.4mm	457.2mm	482.6mm	533.4mm	558.8mm	609.6mm	635.0mm	685.8mm	711.2mm
SPECIFY MODEL	SGR 500	SGR 600	SGR 700	SGR 800	SGR 900	SGR 1000	SGR 1100	SGR 1200	SGR 1300	SGR 1400	SGR 1500	SGR 1600

Model Data Floor to Wall Covers

JOINT WIDTH (JW)	127.0mm	152.4mm	177.8mm	203.2mm	228.6mm	254.0mm	279.4mm	304.8mm	330.2mm	355.6mm	381.0mm	406.4mm
MINIMUM OPENING	108.0mm	108.0mm	127.0mm	139.7mm	152.4mm	165.1mm	177.8mm	190.5mm	203.2mm	215.9mm	228.6mm	241.3mm
MAXIMUM OPENING	196.9mm	196.9mm	241.3mm	266.7mm	292.1mm	330.2mm	368.3mm	387.4mm	431.8mm	457.2mm	482.6mm	520.7mm
EXPOSED SURFACE (ES)	215.9mm	241.3mm	279.4mm	304.8mm	342.9mm	368.3mm	406.4mm	431.8mm	469.9mm	495.3mm	533.4mm	558.8mm
SPECIFY MODEL	SGRW 500	SGRW 600	SGRW 700	SGRW 800	SGRW 900	SGRW 1000	SGRW 1100	SGRW 1200	SGRW 1300	SGRW 1400	SGRW 1500	SGRW 1600

SGR and SGP have same model data. SGRW and SGPW have same model data. For odd and larger sized joints, call 1300 272 602 or visit www.c-sgroup.com.au

*Can be modified to provide up to 100% movement

PAN Seismic Floor Covers 100mm - Up

Use this cover for:

- Interior and exterior seismic applications where cover concealment is desired in deeper floor finishes.
- Applications with floor finishes of up to 38mm thick.
- Heavy duty versions available for limited vehicular access.
- Corrugated extruded centre plate (eliminates warpage from welding).

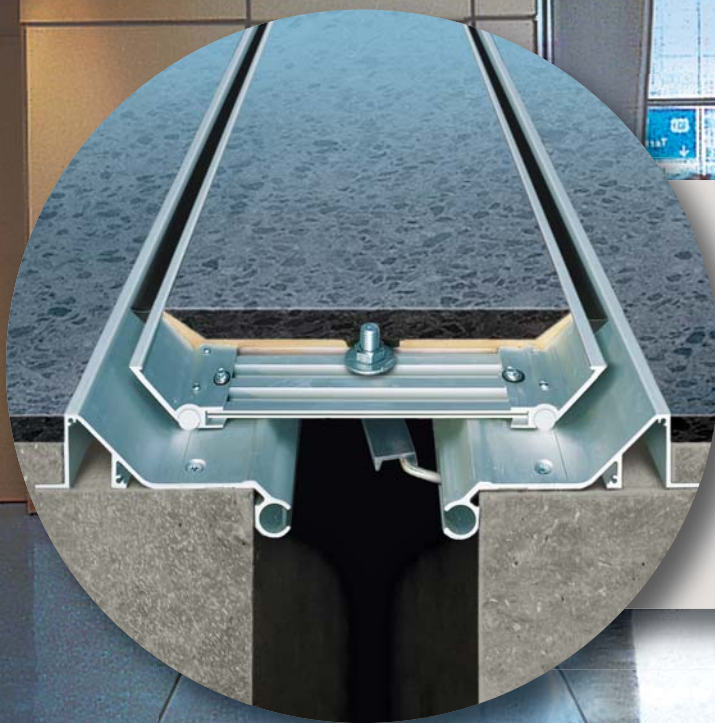

How it works:

Unobtrusive C/S Seismic Pan Covers provide movement up to 1524mm. During minor thermal movement the joint covers' sealant and backer rod expands and contracts. During seismic activity the centre pan assembly lifts for additional movement and returns to normal position after the event.

For comprehensive information on these products, visit www.c-sgroup.com.au

Cycling

Center Pan Lifts Clear Of Moving Structure But Remains Centered Over Opening

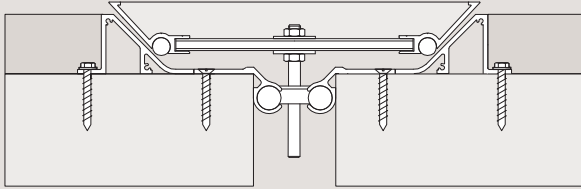

SSR Contracted

Unique Gravity Activated Turnbar System Returns Cover To Normal Position After Event

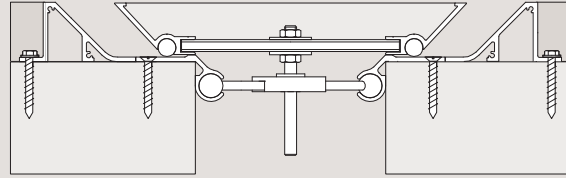

SSR Expanded

Floor Covers

Extruded Aluminum Center Pan

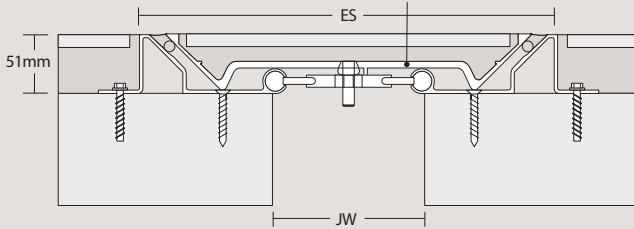

SSR-200-600

Modular Pan Construction For High Strength

Non-metallic bearing for low friction movement

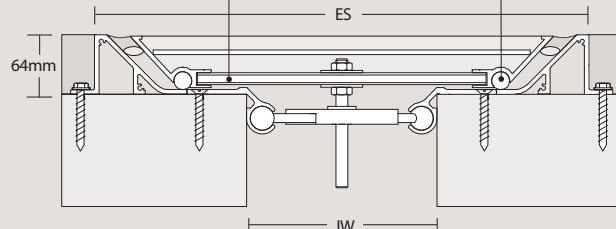

SSR-800-1600

Floor to Wall Covers

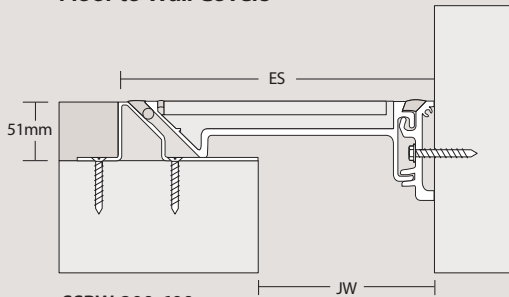

SSRW-200-600

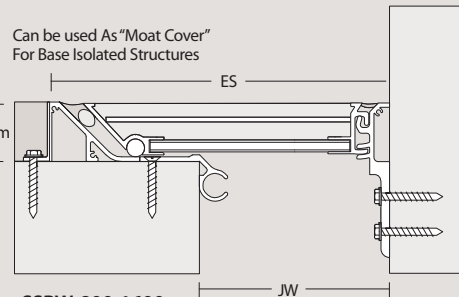

SSRW-800-1600

Can be used As "Moat Cover" For Base Isolated Structures

Model Data Floor to Floor Covers

JOINT WIDTH (JW)	50.8mm	101.6mm	152.4mm	203.2mm	254.0mm	304.8mm	355.6mm	406.4mm
MINIMUM OPENING	19.1mm	19.1mm	19.1mm	57.2mm	57.2mm	57.2mm	57.2mm	57.2mm
MAXIMUM OPENING	101.6mm	152.4mm	241.3mm	330.2mm	406.4mm	482.6mm	558.8mm	635.0mm
EXPOSED SURFACE (ES)	350.8mm	350.8mm	450.9mm	527.1mm	603.3mm	679.5mm	755.7mm	831.9mm
SPECIFY MODEL	SSR 200	SSR 400	SSR 600	SSR 800	SSR 1000	SSR 1200	SSR 1400	SSR 1600

Model Data Floor to Wall Covers

JOINT WIDTH (JW)	50.8mm	101.6mm	152.4mm	203.2mm	254.0mm	304.8mm	355.6mm	406.4mm
MINIMUM OPENING	25.4mm	25.4mm	25.4mm	76.2mm	76.2mm	76.2mm	76.2mm	76.2mm
MAXIMUM OPENING	152.4mm	152.4mm	304.8mm	266.7mm	330.2mm	393.7mm	457.2mm	520.7mm
EXPOSED SURFACE (ES)	235.0mm	235.0mm	387.4mm	365.3mm	428.8mm	492.3mm	555.8mm	617.7mm
SPECIFY MODEL	SSRW 200	SSRW 400	SSRW 600	SSRW 800	SSRW 1000	SSRW 1200	SSRW 1400	SSRW 1600

For odd and larger sized joints, call 1300 272 602 or visit www.c-sgroup.com.au

Standard Allway Metal Floor Covers 25mm - 150mm

Use this cover for:

- For applications with heavy rolling loads.
- Interior applications where low maintenance is desirable or for tamperproof applications.
- Suitable for most floor finishes – frame configuration variable to suit selected finish.

How it works:

C/S' new APF Metal Floor Covers feature a free-floating aluminum center assembly that spans the joint and slides between the cover's frame assemblies to allow for movement when required. APF Metal covers can withstand heavy rolling loads and are perfect for transit centers.



For comprehensive information on these products, visit www.c-sgroup.com.au

Floor Covers

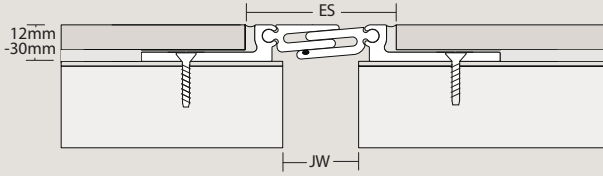

APF 25

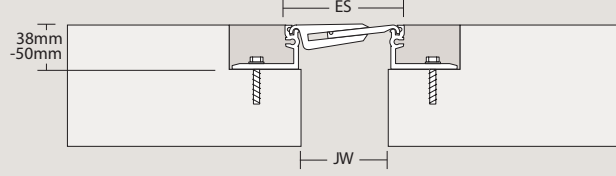

APF 50

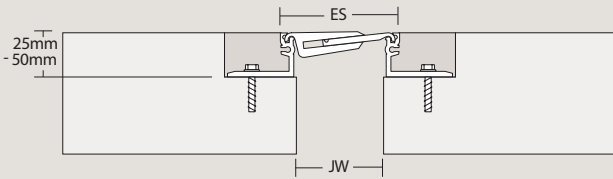

APF 100

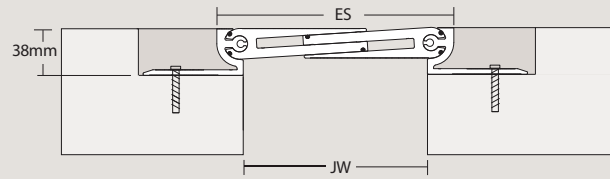

APF 150

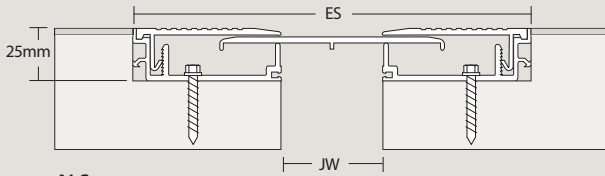

ALS

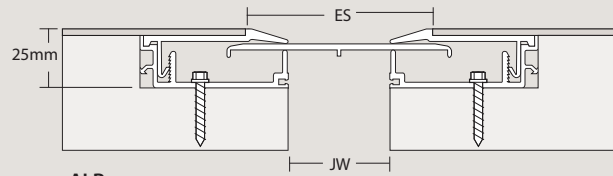

ALR

Floor to Wall Covers

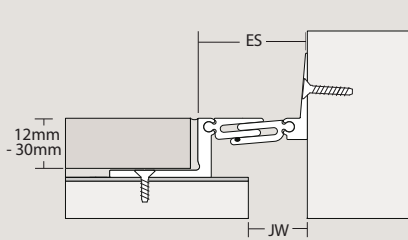

APFW 25

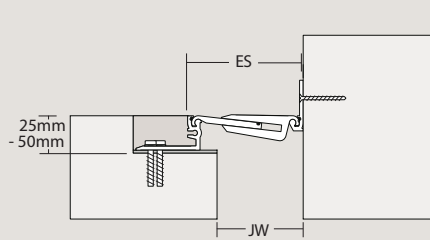

APFW 50-100

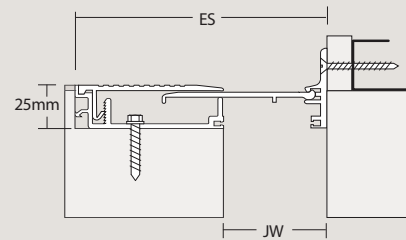

ALSW

Model Data Floor to Floor Covers

JOINT WIDTH (JW)	25.0mm	50.0mm	100.0mm	150.0mm	50.8mm	101.6mm	50.8mm	101.6mm
MINIMUM OPENING	20.0mm	40.0mm	80.0mm	112.0mm	0.0mm	22.4mm	0.0mm	22.4mm
MAXIMUM OPENING	30.0mm	60.0mm	120.0mm	188.0mm	101.6mm	177.8mm	101.6mm	177.8mm
EXPOSED SURFACE (ES)	43.0mm	83.0mm	134.0mm	195.0mm	92.7mm	163.6mm	196.9mm	298.5mm
SPECIFY MODEL	APF 25	APF 50	APF 100	APF 150	ALR 200	ALR 400	ALS 200	ALS 400

Model Data Floor to Wall Covers

JOINT WIDTH (JW)	25.0mm	50.0mm	100.0mm	50.8mm	101.6mm	50.8mm	101.6mm
MINIMUM OPENING	20.0mm	40.0mm	80.0mm	25.4mm	62.0mm	25.4mm	62.0mm
MAXIMUM OPENING	30.0mm	60.0mm	120.0mm	76.2mm	139.7mm	76.2mm	139.7mm
EXPOSED SURFACE (ES)	43.0mm	83.0mm	134.0mm	71.4mm	131.8mm	124.0mm	200.2mm
SPECIFY MODEL	APFW 25	APFW 50	APFW 100	ALRW 200	ALRW 400	ALSW 200	ALSW 400

For odd and larger sized joints, call 1300 272 602 or visit www.c-sgroup.com.au

Seismic Allway Metal Floor Covers 100mm - Up

Use this cover for:

- Interior or exterior seismic applications.
- Limited vehicular access (heavy duty models).



How it works:

C/S Seismic Metal Floor Covers can provide 760mm of plus movement during a seismic event. The cover's self centering aluminum centre plate remains flush during thermal movement, but temporarily displaces and slides over the floor surface during seismic movement.

For comprehensive information on these products, visit www.c-sgroup.com.au

Floor Covers

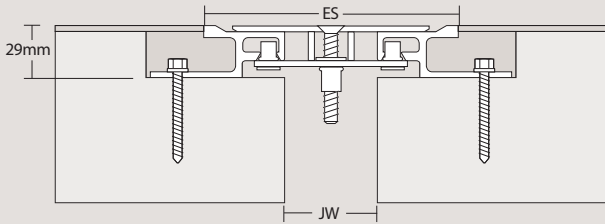

SJPF*

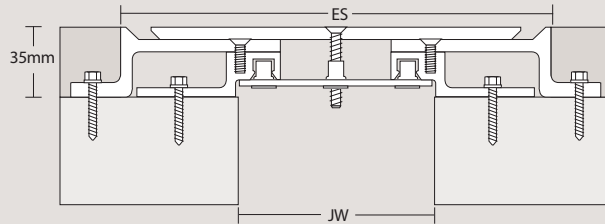

SJHD*
Heavy Duty 907Kg. Point Load

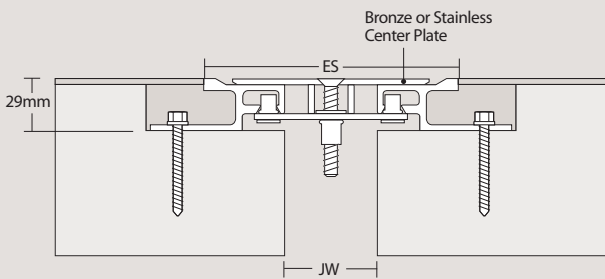

SJPFB/SS*

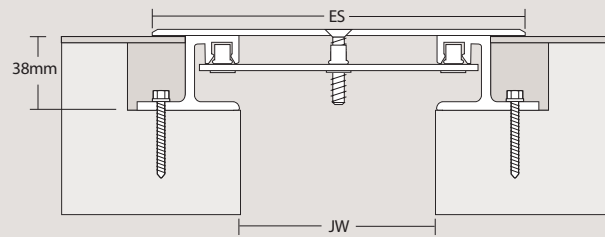

SJP*

Floor to Wall Covers

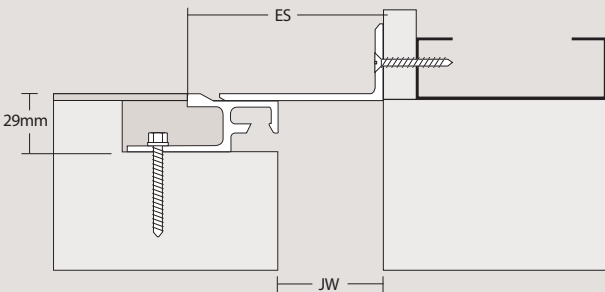

SJPFW*

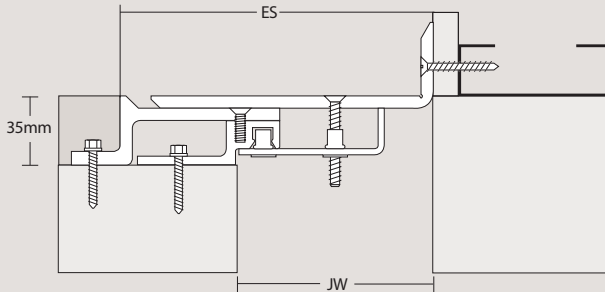

SJWHD*
Heavy Duty 907Kg. Point Load

Model Data Floor to Floor Covers

JOINT WIDTH (JW)	101.6mm	152.4mm	203.2mm	50.8mm	101.6mm	152.4mm	50.8mm	101.6mm	152.4mm	203.2mm	254.0mm	304.8mm	355.6mm	406.4mm
MINIMUM OPENING	69.9mm	69.9mm	69.9mm	25.4mm	25.4mm	25.4mm	25.4mm	25.4mm	25.4mm	25.4mm	25.4mm	25.4mm	25.4mm	25.4mm
MAXIMUM OPENING	162.1mm	235.0	358.9mm	101.6mm	165.1mm	251.0mm	114.3mm	190.5mm	282.7mm	362.0mm	425.5mm	533.4mm	603.3mm	616.0mm
EXPOSED SURFACE (ES)	222.3mm	298.5mm	374.7mm	127.0mm	203.2mm	292.1mm	88.9mm	190.5mm	301.8mm	381.0mm	455.7mm	533.4mm	606.6mm	685.8mm
SPECIFY MODEL	SJ-HD400	SJ-HD600	SJ-HD800	SJPF 200	SJPF 400	SJPF 600	SJP 200	SJP 400	SJP 600	SJP 800	SJP 1000	SJP 1200	SJP 1400	SJP 1600

Model Data Floor to Wall Covers

JOINT WIDTH (JW)	101.6mm	152.4mm	203.2mm	50.8mm	101.6mm	152.4mm	50.8mm	101.6mm	152.4mm	203.2mm	254.0mm	304.8mm	355.6mm	406.4mm
MINIMUM OPENING	85.9mm	111.3mm	136.7mm	0.0mm	0.0mm	0.0mm	0.0mm	0.0mm	0.0mm	114.3mm	139.7mm	165.1mm	190.5mm	215.9mm
MAXIMUM OPENING	131.8mm	193.8mm	280.9mm	76.2mm	133.4mm	201.7mm	82.6mm	146.1mm	215.9mm	254.0mm	338.1mm	419.1mm	476.3mm	508.0mm
EXPOSED SURFACE (ES)	162.1mm	225.6mm	289.1mm	95.3mm	152.4mm	222.3mm	82.6mm	146.1mm	228.6mm	292.1mm	355.6mm	419.1mm	482.6mm	546.1mm
SPECIFY MODEL	SJW-HD400	SJW-HD600	SJW-HD800	SJPFW 200	SJPFW 400	SJPFW 600	SJPW 200	SJPW 400	SJPW 600	SJPW 800	SJPW 1000	SJPW 1200	SJPW 1400	SJPW 1600

For odd and larger sized joints, call 1300 272 602 or visit www.c-sgroup.com.au

*Can be modified to provide up to 100% movement.

Standard Allway Metal Floor Covers 25mm - 50mm



With its clean and sleek finish coupled with the ability to withstand high rolling loads, KLP is suited for both indoor and outdoor use. The unparalleled cover design allows for significant horizontal movement in the floor slab as well as hiding any fasteners from sight, while the turn bars keep the cover plate centred at all times. The maintenance of the system is kept to a minimum due to the flush aluminium design preventing dirt from entering the joints.

Floor Covers

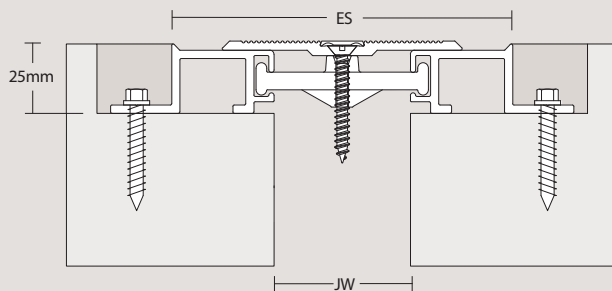

KLP50-25

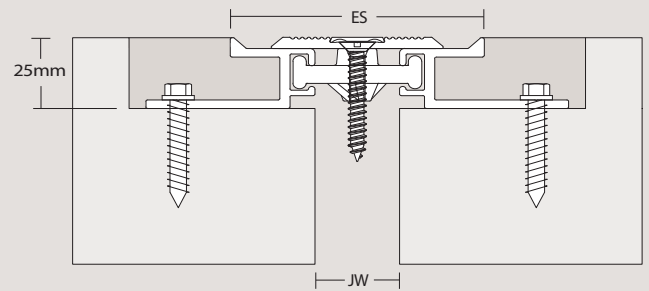

KLP25-25

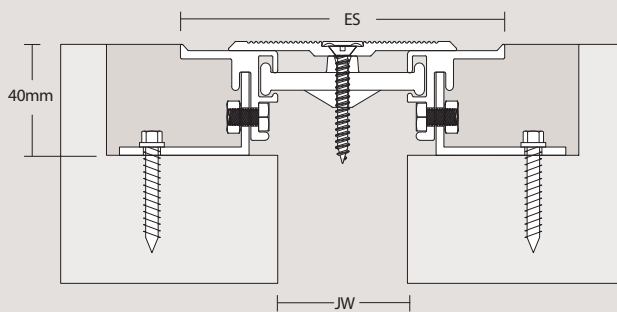

KLP50-40

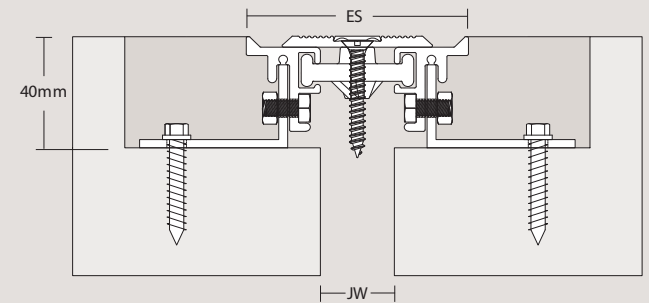

KLP25-40

Model Data Floor to Floor Covers

JOINT WIDTH (JW)	25.0mm	25.0mm	50.0mm	50.0mm
MINIMUM OPENING	12.5mm	12.5mm	25.0mm	25.0mm
MAXIMUM OPENING	37.5mm	37.5mm	75.0mm	75.0mm
EXPOSED SURFACE (ES)	75.0mm	75.0mm	125.0mm	125.0mm
SPECIFY MODEL	KLP25-25	KLP25-40	KLP50-25	KLP50-40

Aluminium Minimal Movement Covers



CSFM is a surface mounted minimal movement expansion joint for vinyl floors. CSFM was purposely designed to accommodate 3mm vinyl and carpet tiles for use in all areas of commercial flooring. With a natural anodise of 25UM coating with aluminium alloy 6061-T6, CSFM will compliment all your architectural needs.

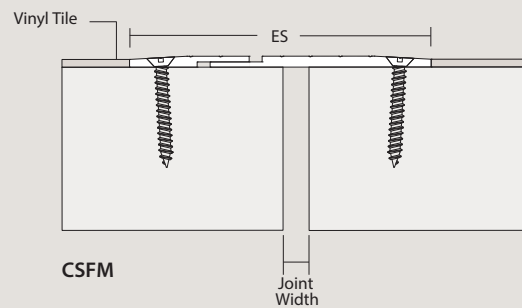

JOINT WIDTH (JW)	5mm-12mm
MOVEMENT	± 5mm
EXPOSED SURFACE (ES)	116mm
SPECIFY M DEL	CSFM

Flush Thinline Wall & Ceiling Covers 25mm - 255mm

Use this cover for:

- Wall and ceiling applications to align with and match flush Thinline covers used in the floor.
- Suitable for most wall and ceiling finishes – frame configuration variable to suit selected finish.
- Where hygiene is important.



How it works:

C/S Flush Thinline Wall and Ceiling Covers feature Santoprene gaskets that integrate perfectly with most wall and ceiling surfaces. These single gasket covers provide multi-directional movement and accommodate both thermal and seismic movement.

➤ For comprehensive information on these products, visit www.c-sgroup.com.au

Wall Covers

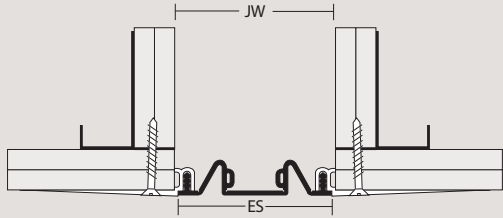

FWF

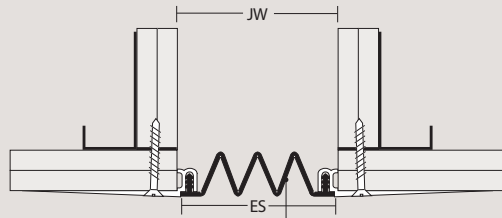

FWS

Ribbed Gasket Offers Better Movement

Corner Wall Covers

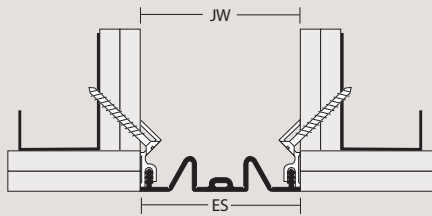

FWF-M

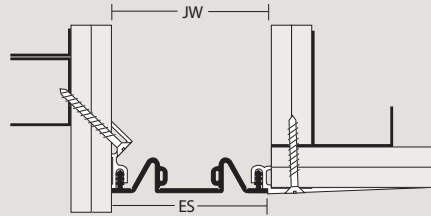

FWFC

Ceiling Covers

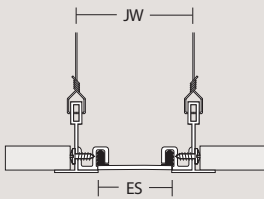

FCF

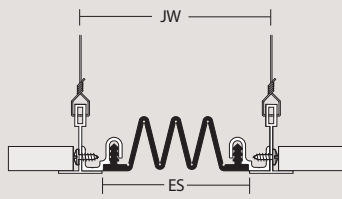

FCS

Corner Ceiling Covers

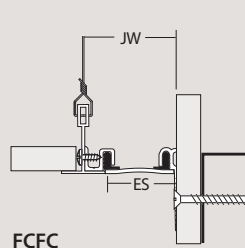

FCFC

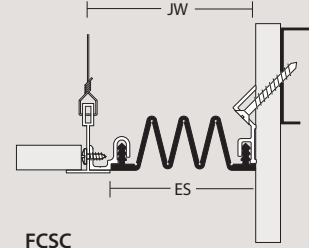

FCSC

Gasket Colours

Black

White

Grey

Greige

Note: Custom colours available. Call 1300 272 602

Model Data Wall to Wall Covers

JOINT WIDTH (JW)	25.4mm	50.8mm	76.2mm	101.6mm	50.8mm	76.2mm	101.6mm
MINIMUM OPENING	14.2mm	14.2mm	25.4mm	25.4mm	25.4mm	25.4mm	25.4mm
MAXIMUM OPENING	31.8mm	63.5mm	114.3mm	152.4mm	101.6mm	152.4mm	203.2mm
EXPOSED SURFACE (ES)	26.9mm	52.3mm	76.2mm	101.6mm	50.8mm	76.2mm	101.6mm
SPECIFY MODEL	FWF 100	FWF 200	FWF 300	FWF 400	FWS 200	FWS 300	FWS 400

Model Data Ceiling Covers

25.4mm	50.8mm	76.2mm	101.6mm	50.8mm	76.2mm	101.6mm
MINIMUM OPENING	14.2mm	14.2mm	25.4mm	25.4mm	25.4mm	25.4mm
MAXIMUM OPENING	31.8mm	63.5mm	114.3mm	152.4mm	101.6mm	152.4mm
EXPOSED SURFACE (ES)	20.6mm	41.4mm	76.2mm	101.6mm	50.8mm	76.2mm
SPECIFY MODEL	FCF 100	FCF 200	FCF 300	FCF 400	FCS 200	FCS 300

Model Data Corner Wall Covers

JOINT WIDTH (JW)	25.4mm	50.8mm	76.2mm	101.6mm	50.8mm	76.2mm	101.6mm
MINIMUM OPENING	19.1mm	19.1mm	25.4mm	25.4mm	25.4mm	25.4mm	25.4mm
MAXIMUM OPENING	31.8mm	63.5mm	114.3mm	152.4mm	101.6mm	152.4mm	203.2mm
EXPOSED SURFACE (ES)	22.4mm	50.8mm	76.2mm	101.6mm	50.8mm	76.2mm	101.6mm
SPECIFY MODEL	FWFC 100	FWFC 200	FWFC 300	FWFC 400	FWSC 200	FWSC 300	FWSC 400

Model Data Corner Ceiling Covers

25.4mm	50.8mm	76.2mm	101.6mm	50.8mm	76.2mm	101.6mm
MINIMUM OPENING	19.1mm	19.1mm	25.4mm	25.4mm	25.4mm	25.4mm
MAXIMUM OPENING	31.8mm	63.5mm	114.3mm	152.4mm	101.6mm	152.4mm
EXPOSED SURFACE (ES)	25.4mm	44.5mm	76.2mm	101.6mm	50.8mm	76.2mm
SPECIFY MODEL	FCFC 100	FCFC 200	FCFC 300	FCFC 400	FCSC 200	FCSC 300

For odd and larger sized joints, call 1300 272 602 or visit www.c-sgroup.com.au

Flush Twinline Wall & Ceiling Covers 25mm - Up

Use this cover for:

- Wall and ceiling applications to match flush Twinline covers used in the floor.
- Suitable for most wall and ceiling finishes.



How it works:

Flush Twinline Wall and Ceiling Covers for standard and seismic application feature dual Santoprene gaskets that expand and compress during movement. The durable aluminum center plate can be painted to match the wall finish and it temporarily displaces during a seismic event.

For comprehensive information on these products, visit www.c-sgroup.com.au

Wall Covers

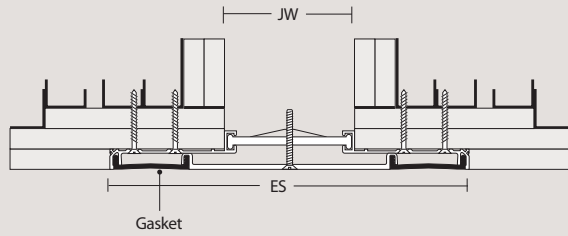

GTW

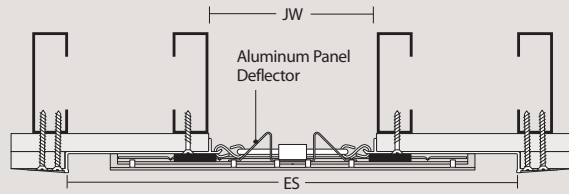

LAF

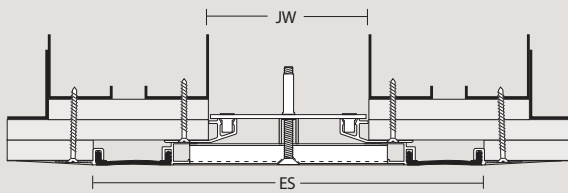

SGW

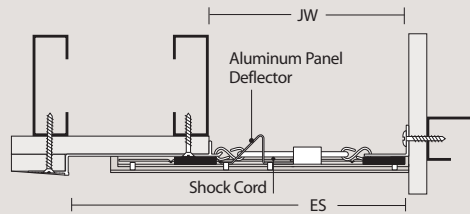

LAFC

Corner Wall Covers

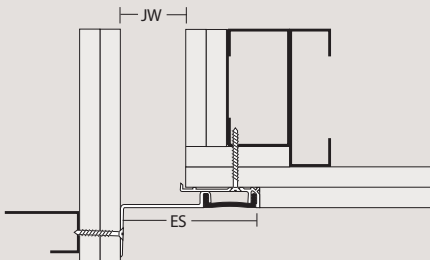

GTWC

Ceiling Cover

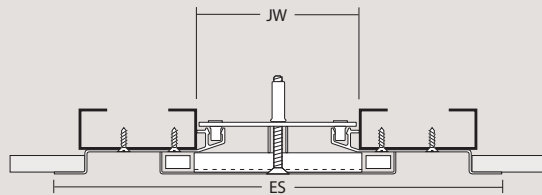

SGC

Gasket Colours

Black

White

Grey

Greige

Note: Custom colours available. Call 1300 272 602

Model Data Wall Covers

JOINT WIDTH (JW)	50.8mm	101.6mm	152.4mm	203.2mm	254.0mm	304.8mm	355.6mm	406.4mm	101.6mm	152.4mm	203.2mm	254.0mm	304.8mm	355.6mm	406.4mm
MINIMUM OPENING	31.8mm	31.8mm	69.9mm	69.9mm	69.9mm	69.9mm	69.9mm	69.9mm	25.4mm	25.4mm	25.4mm	25.4mm	25.4mm	25.4mm	25.4mm
MAXIMUM OPENING	95.3mm	158.8mm	235.0mm	323.9mm	400.1mm	476.3mm	552.5mm	628.7mm	203.2mm	304.8mm	406.4mm	508.0mm	609.6mm	711.2mm	812.8mm
EXPOSED SURFACE (ES)	165.1mm	279.4mm	330.2mm	406.4mm	482.6mm	558.8mm	635.0mm	711.2mm	363.5mm	414.3mm	465.1mm	515.9mm	566.7mm	617.5mm	668.3mm
SPECIFY MODEL	GTW 200	GTW 400	SGW 600	SGW 800	SGW 1000	SGW 1200	SGW 1400	SGW 1600	LAF 400	LAF 600	LAF 800	LAF 1000	LAF 1200	LAF 1400	LAF 1600

Model Data Corner Wall Covers

JOINT WIDTH (JKW)	50.8mm	101.6mm	152.4mm	203.2mm	254.0mm	304.8mm	355.6mm	406.4mm	101.6mm	152.4mm	203.2mm	254.0mm	304.8mm	355.6mm	406.4mm
MINIMUM OPENING	25.4mm	63.5mm	108.0mm	139.7mm	165.1mm	190.5mm	215.9mm	241.3mm	50.8mm	50.8mm	50.8mm	50.8mm	50.8mm	50.8mm	50.8mm
MAXIMUM OPENING	76.2mm	139.7mm	190.5mm	260.4mm	323.9mm	387.4mm	450.9mm	514.4mm	203.2mm	304.8mm	406.4mm	508.0mm	609.6mm	711.2mm	812.8mm
EXPOSED SURFACE (ES)	108.0mm	190.5mm	241.3mm	304.8mm	368.3mm	431.8mm	495.3mm	558.8mm	231.9mm	282.7mm	333.5mm	384.3mm	435.1mm	485.9mm	536.7mm
SPECIFY MODEL	GTWC 200	GTWC 400	SGWC 600	SGWC 800	SGWC 1000	SGWC 1200	SGWC 1400	SGWC 1600	LAFC 400	LAFC 600	LAFC 800	LAFC 1000	LAFC 1200	LAFC 1400	LAFC 1600

For odd and larger sized joints, call 1300 272 602 or visit www.c-sgroup.com.au

Allway Metal Wall & Ceiling Covers 25mm - 100mm

Use this cover for:

- Interior applications to match Allway metal floor covers.
- Standard aluminum covers supplied clear anodized, but bronze or stainless top plates available.



How it works:

Allway Metal Wall Covers feature a free-floating aluminum centre plate that spans the joint and slides between the frame assemblies to allow for 50-100% movement of joint width when required. Entire cover may be painted to match wall finishes.

➤ For comprehensive information on these products, visit www.c-sgroup.com.au

Wall Covers

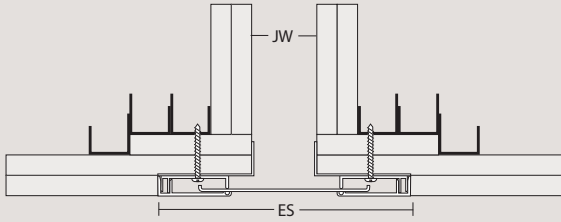

AFW

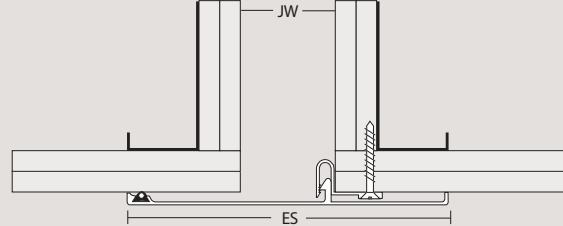

ASM

Corner Wall Covers

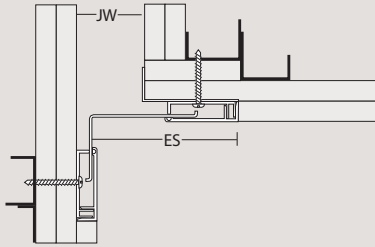

AFWC

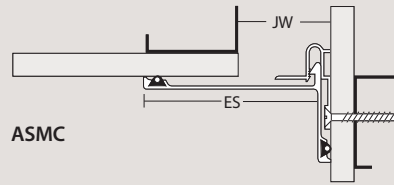

ASMC

Ceiling Covers

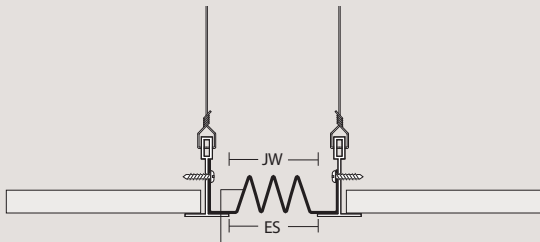

HC

Dual Durometer Gasket

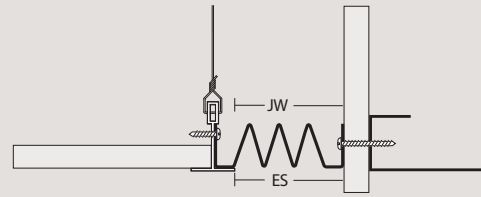

HCW

Model Data Wall Covers

JOINT WIDTH (JW)	25.4mm	50.8mm	76.2mm	101.6mm	25.4mm	50.8mm	76.2mm	101.6mm
MINIMUM OPENING	6.4mm	9.7mm	0.0mm	25.4mm	9.7mm	9.7mm	9.7mm	9.7mm
MAXIMUM OPENING	47.8mm	88.9mm	162.1mm	187.5mm	38.1mm	76.2mm	152.4mm	152.4mm
EXPOSED SURFACE (ES)	127.0mm	196.9mm	273.1mm	298.5mm	79.5mm	117.6mm	193.8mm	193.8mm
SPECIFY MODEL	AFW 100	AFW 200	AFW 300	AFW 400	ASM 100	ASM 200	ASM 300	ASM 400

Model Data Ceiling Covers

	25.4mm	50.8mm	76.2mm	101.6mm
MINIMUM OPENING	0.0mm	0.0mm	0.0mm	0.0mm
MAXIMUM OPENING	127.0mm	152.4mm	228.6mm	254.0mm
EXPOSED SURFACE (ES)	25.4mm	50.8mm	76.2mm	101.6mm
SPECIFY MODEL	HC 100	HC 200	HC 300	HC 400

Model Data Corner Wall Covers

JOINT WIDTH (JW)	25.4mm	50.8mm	76.2mm	101.6mm	25.4mm	50.8mm	76.2mm	101.6mm
MINIMUM OPENING	16.0mm	30.2mm	38.1mm	63.5mm	12.7mm	12.7mm	12.7mm	12.7mm
MAXIMUM OPENING	36.6mm	69.9mm	119.1mm	144.5mm	38.1mm	76.2mm	152.4mm	152.4mm
EXPOSED SURFACE (ES)	60.2mm	108.0mm	158.8mm	184.2mm	47.8mm	85.9mm	162.1mm	162.1mm
SPECIFY MODEL	AFWC 100	AFWC 200	AFWC 300	AFWC 400	ASMC 100	ASMC 200	ASMC 300	ASMC 400

Model Data Corner Ceiling Covers

	25.4mm	50.8mm	76.2mm	101.6mm
MINIMUM OPENING	0.0mm	0.0mm	0.0mm	0.0mm
MAXIMUM OPENING	127.0mm	152.4mm	228.6mm	254.0mm
EXPOSED SURFACE (ES)	38.1mm	63.5mm	88.9mm	114.3mm
SPECIFY MODEL	HCW 100	HCW 200	HCW 300	HCW 400

For odd and larger sized joints, call 1300 272 602 or visit www.c-sgroup.com.au

Exterior Wall Flexible Seals 25mm - Up

Use this cover for:

- Exterior vertical applications where weather protection is critical.
- Frames designed to attach to most external skin structures.
- 50mm to 915mm joint sizes with multi-directional movement.
- Factory welded transitions available.
- Four standard gasket colours(12 standard VF colours).

How it works:

C/S Exterior Flexible Seals in four standard and custom colours are designed to provide weather tight, multi-directional movement on all external skin structures. These flush seals can provide up to 813mm of movement in four directions.

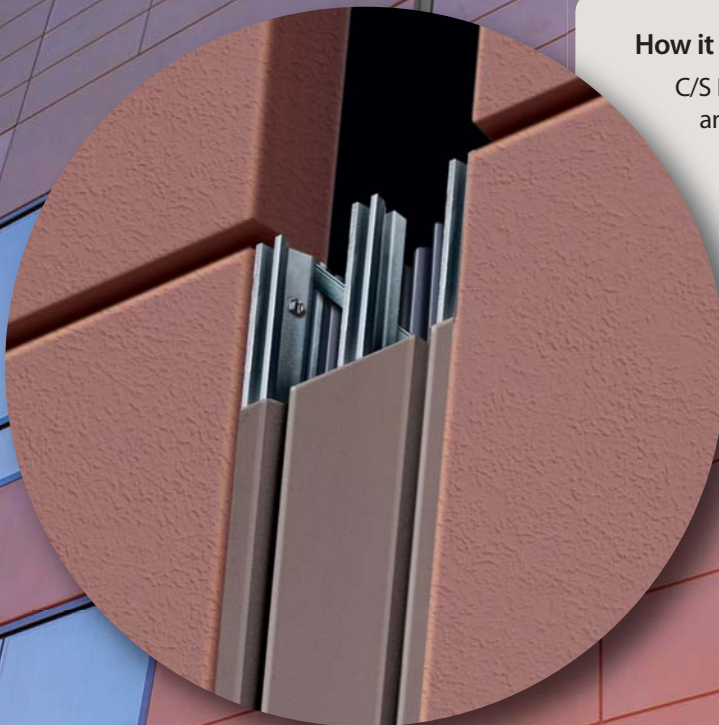

For comprehensive information on these products, visit www.c-sgroup.com.au

Wall Covers

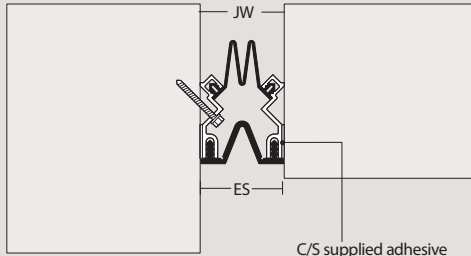

SF-200
(typical corner condition)

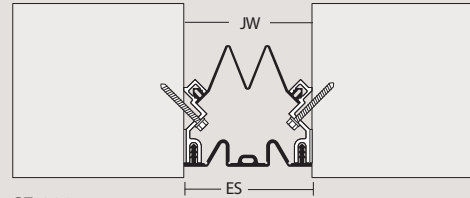

SF-300

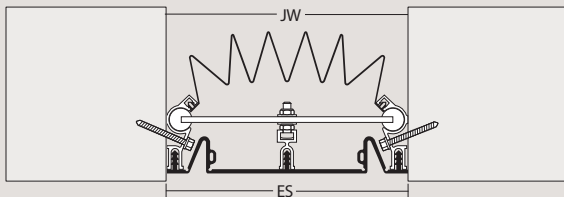

SF-800

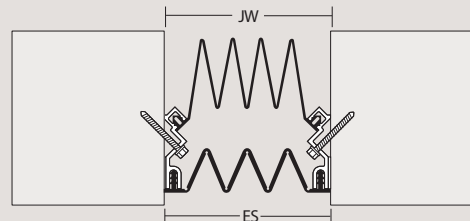

SC-400

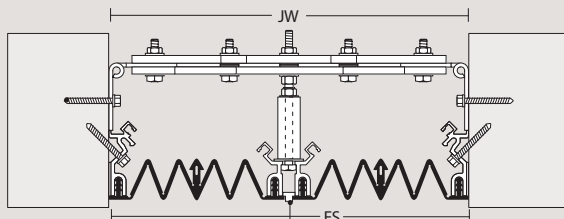

SC-1200
Cont. Extruded Alum. Center Mullion

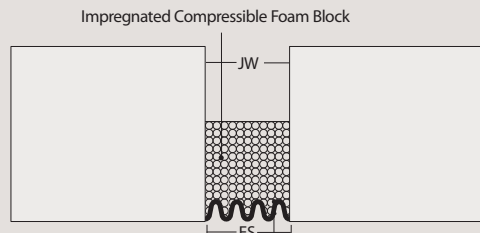

VF
Impregnated Compressible Foam Block
Factory Applied Silicone Face

Model VF Colours



Gasket Colours



Note: Custom colours available. Call 1300 272 602.

Model Data Wall Covers

JOINT WIDTH (JW)	50.8mm	76.2mm	101.6mm	127.0mm	152.4mm	177.8mm	203.2mm	228.6mm	254.0mm	304.8mm	355.6mm	406.4mm	25.4mm	50.8mm	76.2mm	101.6mm	152.4mm	203.2mm
MINIMUM OPENING	31.8mm	31.8mm	31.8mm	31.8mm	44.5mm	63.5mm	63.5mm	63.5mm	63.5mm	152.4mm	152.4mm	152.4mm	12.7mm	25.4mm	38.1mm	50.8mm	76.2mm	101.6mm
MAXIMUM OPENING	76.2mm	114.3mm	152.4mm	190.5mm	228.6mm	266.7mm	304.8mm	342.9mm	381.1mm	457.2mm	533.4mm	609.6mm	38.1mm	76.2mm	114.3mm	152.4mm	228.6mm	304.8mm
EXPOSED SURFACE (ES)	50.8mm	76.2mm	101.6mm	127.0mm	152.4mm	177.8mm	203.2mm	228.6mm	254.0mm	304.8mm	355.6mm	406.4mm	25.4mm	50.8mm	76.2mm	101.6mm	152.4mm	203.2mm
SPECIFY MODEL	SF 200	SF 300	SF 400	SF 500	SF 600	SF 700	SF 800	SF 900	SF 1000	SF 1200	SF 1400	SF 1600	VF 100	VF 200	VF 300	VF 400	VF 600	VF 800

Model Data Wall Covers

JOINT WIDTH (JW)	101.6mm	127.0mm	152.4mm	177.8mm	203.2mm	228.6mm	254.0mm	279.4mm	304.8mm	330.2mm	355.6mm	381.0mm	406mm
MINIMUM OPENING	31.8mm	44.5mm	44.5mm	63.5mm	63.5mm	63.5mm	63.5mm	152.4mm	152.4mm	152.4mm	152.4mm	152.4mm	152.4mm
MAXIMUM OPENING	203.2mm	254.0mm	304.8mm	355.6mm	406.4mm	457.2mm	508.0mm	558.8mm	609.6mm	660.4mm	711.2mm	762.0mm	812.8mm
EXPOSED SURFACE (ES)	101.6mm	127.0mm	152.4mm	176.8mm	203.2mm	228.6mm	254.0mm	279.4mm	304.8mm	330.2mm	355.6mm	381.0mm	406.4mm
SPECIFY MODEL	SC 400	SC 500	SC 600	SC 700	SC 800	SC 900	SC 1000	SC 1100	SC 1200	SC 1300	SC 1400	SC 1500	SC 1600

For odd and larger sized joints, call 1300 272 602 or visit www.c-sgroup.com.au

Seismic Exterior Wall Covers 205mm - Up

Use this cover for:

- Exterior seismic wall applications where cover concealment is desired within curtain wall finishes.
- Lightweight finish applications up to 14mm thick (supplied by others).
- Zero maintenance required after an earthquake.
- Where high wind loads are expected.

How it works:

Seismic Flush Exterior Wall Covers integrate curtain wall finishes into the covers' ladder system to make the covers imperceptible. The covers release from the wall on one side to provide full seismic movement and return to the closed position after an event via its counterweight system.

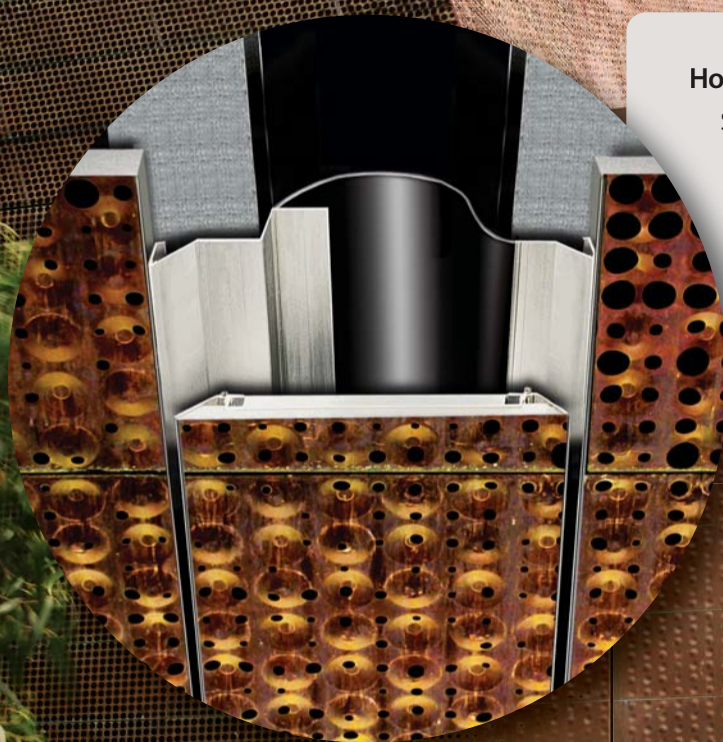

➤ For comprehensive information on these products, visit www.c-sgroup.com.au

Cycling

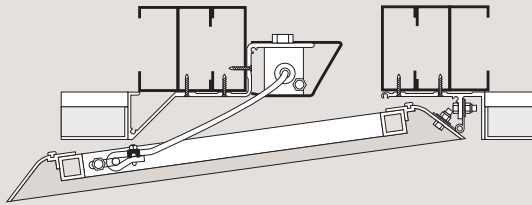

XLS Contracted Counterweight Cord (magnet not shown)

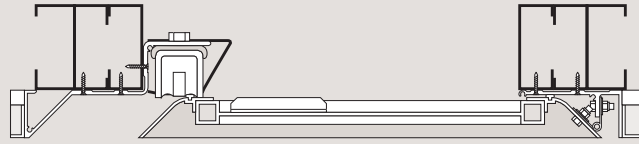

XLS Expanded Magnet (counterweight cord not shown)

Wall Covers

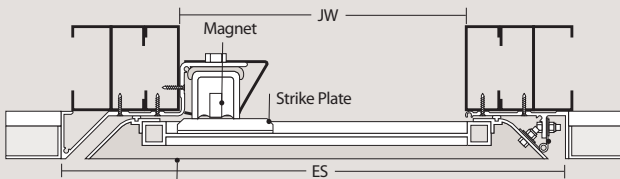

XLS Wall Panels Field Installed and Supplied by Others

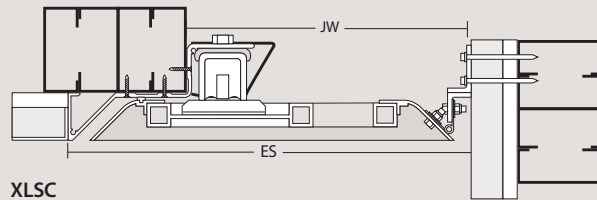

XLSC

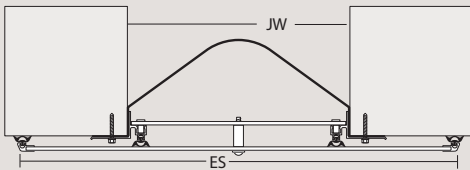

ESW

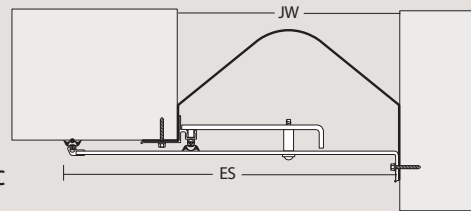

ESC

Model Data Wall Covers

JOINT WIDTH (JW)	203.2mm	254.0mm	304.8mm	355.6mm	406.4mm	101.6mm	203.2mm	304.8mm	406.4mm
MINIMUM OPENING	101.6mm	101.6mm	101.6mm	101.6mm	101.6mm	63.5mm	63.5mm	63.5mm	63.5mm
MAXIMUM OPENING	406.4mm	508.0mm	609.6mm	711.2mm	812.8mm	152.4mm	330.2mm	482.6mm	635.0mm
EXPOSED SURFACE (ES)	439.7mm	490.5mm	541.3mm	592.1mm	642.9mm	304.8mm	457.2mm	609.6mm	762.0mm
SPECIFY MODEL	XLS 800	XLS 1000	XLS 1200	XLS 1400	XLS 1600	ESW 400	ESW 800	ESW 1200	ESW 1600

Model Data Corner Wall Covers

JOINT WIDTH (JW)	203.2mm	254.0mm	304.8mm	355.6mm	406.4mm	101.6mm	203.2mm	304.8mm	406.4mm
MINIMUM OPENING	101.6mm	101.6mm	101.6mm	101.6mm	101.6mm	82.6mm	133.4mm	184.2mm	222.3mm
MAXIMUM OPENING	406.4mm	508.0mm	609.6mm	711.2mm	812.8mm	165.1mm	266.7mm	393.7mm	520.7mm
EXPOSED SURFACE (ES)	330.2mm	381.0mm	431.8mm	482.6mm	533.4mm	203.2mm	330.2mm	457.2mm	584.2mm
SPECIFY MODEL	XLSC 800	XLSC 1000	XLSC 1200	XLSC 1400	XLSC 1600	ESC 400	ESC 800	ESC 1200	ESC 1600

For odd and larger sized joints, call 1300 272 602 or visit www.c-sgroup.com.au

Roof Covers 50mm - Up

Use this cover for:

- Applications in built-up, flat roofs.
- Joint sizes from 50mm - 915mm
- Multi-directional movement requirements.

How it works:

C/S Metal Roof Covers' aluminum frames create a seal to the underside of sliding metal cover plates. Our Flexible Roof Joint Covers' bellows material expands and contracts for multi-directional movement. Both the metal and flexible roof joint covers are available with factory fabricated transitions for all roof conditions.

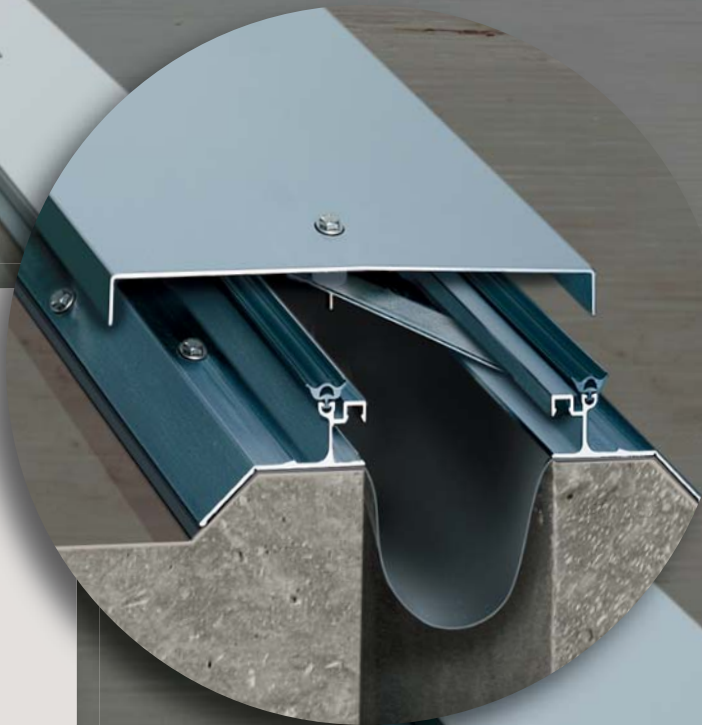

For comprehensive information on these products, visit www.c-sgroup.com.au

Roof To Roof Covers

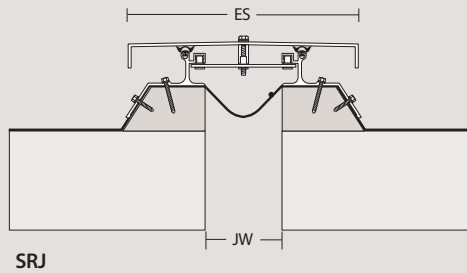
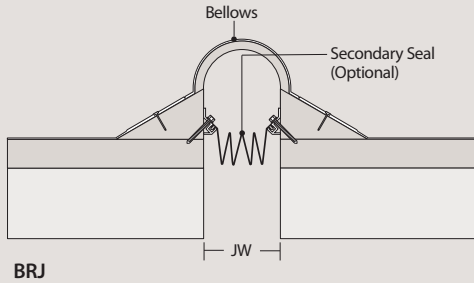

Roof To Wall Covers

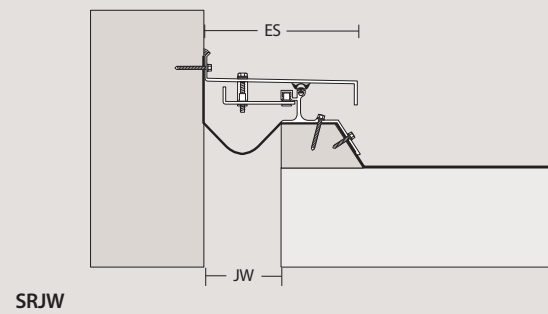
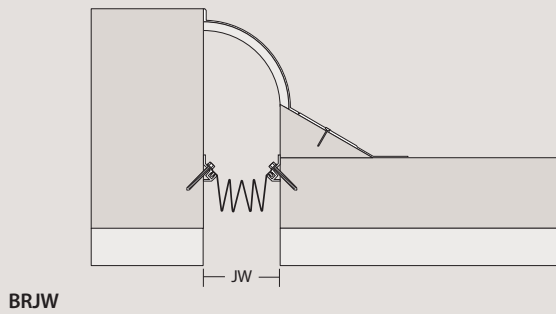

Specialty Roof Joint Covers

High Movement and High Wind Loads

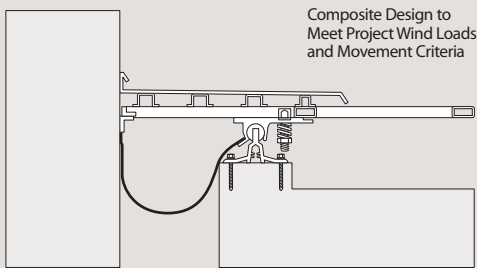

Composite Design to Meet Project Wind Loads and Movement Criteria

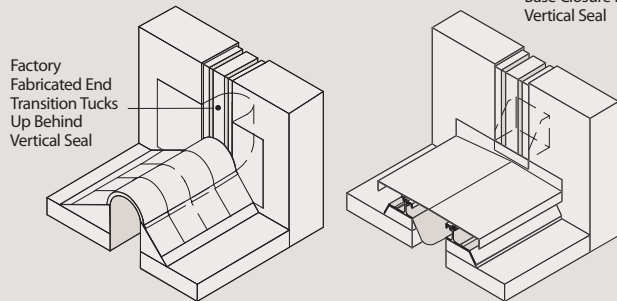

Factory Fabricated End Transition Tucks Up Behind Vertical Seal

Factory Fabricated Base Closure For Vertical Seal

Gyrometric Cover

Parapet Transitions

Model Data Roof Covers

JOINT WIDTH (JW)	50.8m	101.6mm	152.4mm	203.2mm	254.0mm	304.8mm	355.6mm	406.4mm	101.6mm	152.4mm	203.2mm	254.0mm	304.8mm	355.6mm	406.4mm
MINIMUM OPENING	0.0mm	0.0mm	0.0mm	0.0mm	0.0mm	0.0mm	0.0mm	0.0mm	25.4mm	25.4mm	25.4mm	25.4mm	25.4mm	25.4mm	25.4mm
MAXIMUM OPENING	76.2mm	152.4mm	228.6mm	304.8mm	381.0mm	457.2mm	533.4mm	609.6mm	190.5mm	298.5mm	317.5mm	425.5mm	527.1mm	533.4mm	616.0mm
EXPOSED SURFACE (ES)	N/A	N/A	N/A	N/A	N/A	N/A	N/A	N/A	304.8mm	381.0mm	457.2mm	533.4mm	609.6mm	685.8mm	762.0mm
SPECIFY MODEL	BRJ 200	BRJ 400	BRJ 600	BRJ 800	BRJ 1000	BRJ 1200	BRJ 1400	BRJ 1600	SRJ 400	SRJ 600	SRJ 800	SRJ 1000	SRJ 1200	SRJ 1400	SRJ 1600

Model Data Roof to Wall Covers

JOINT WIDTH (JW)	50.8m	101.6mm	152.4mm	203.2mm	254.0mm	304.8mm	355.6mm	406.4mm	101.6mm	152.4mm	203.2mm	254.0mm	304.8mm	355.6mm	406.4mm
MINIMUM OPENING	0.0mm	0.0mm	0.0mm	0.0mm	0.0mm	0.0mm	0.0mm	0.0mm	0.0mm	0.0mm	114.3mm	139.7mm	165.1mm	190.5mm	215.9mm
MAXIMUM OPENING	76.2mm	152.4mm	228.6mm	304.8mm	381.0mm	457.2mm	533.4mm	609.6mm	158.8mm	222.3mm	260.4mm	336.6mm	412.8mm	444.5mm	508.0mm
EXPOSED SURFACE (ES)	N/A	N/A	N/A	N/A	N/A	N/A	N/A	N/A	203.2mm	266.7mm	330.2mm	393.7mm	457.2mm	520.7mm	584.2mm
SPECIFY MODEL	BRJW 200	BRJW 400	BRJW 600	BRJW 800	BRJW 1000	BRJW 1200	BRJW 1400	BRJW 1600	SRJW 400	SRJW 600	SRJW 800	SRJW 1000	SRJW 1200	SRJW 1400	SRJW 1600

For odd and larger sized joints, call 1300 272 602 or visit www.c-sgroup.com.au



Parking Covers & Seals 25mm - 405mm

Use this cover for:

- Seismic applications in parking and other areas with vehicular access.
- Available in standard or HS-20 heavy duty loading.
- New Cast-In-Place Model Available for post-tensioned slab applications.

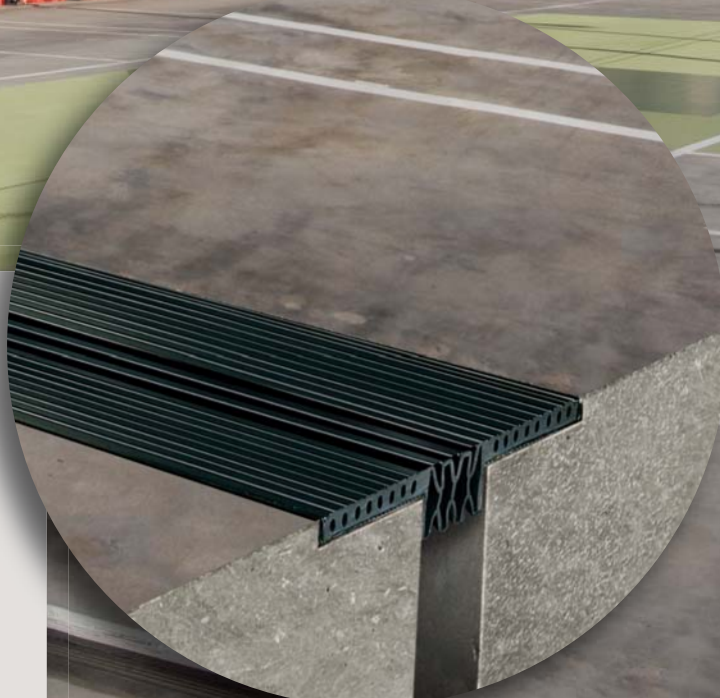

How it works:

C/S Zip Block one-piece EPDM parking seals provide multi-directional movement, and they install in half the time of elastomeric systems. C/S KB Metal Parking Cover offers a full range of movement including 13mm of vertical displacement of slabs. Load dampening design eliminates loose covers. Call 1300 272 602 for a complete catalogue.

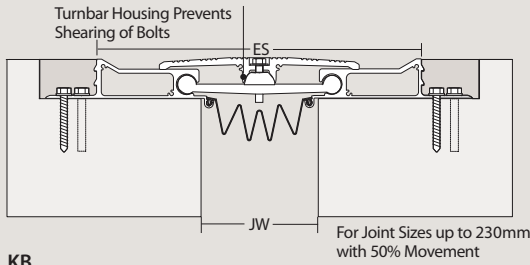

KB

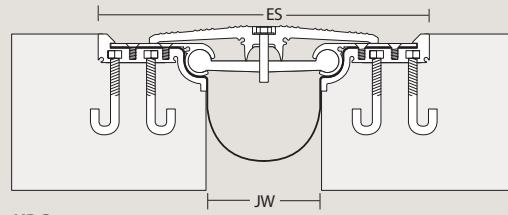

KBC (for cast-in-place)

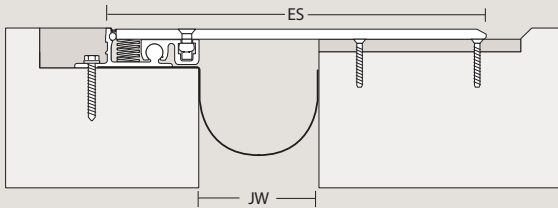

PTCN

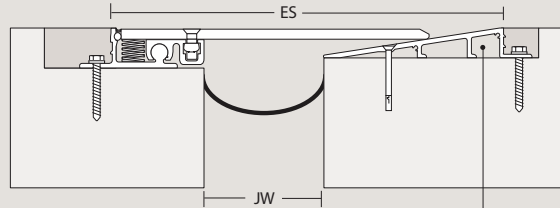

PTC

For Vertical Shear

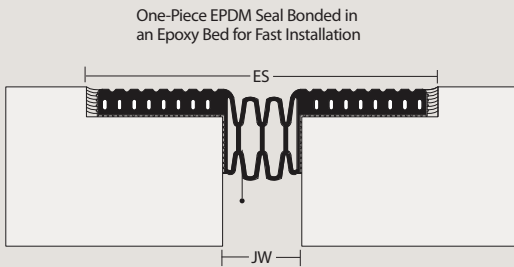

ZB

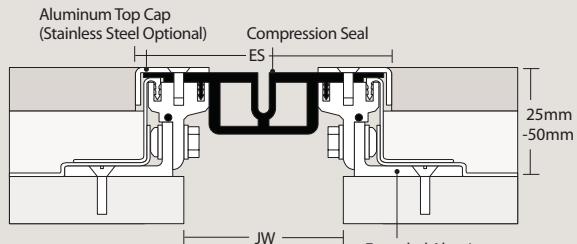

PDA

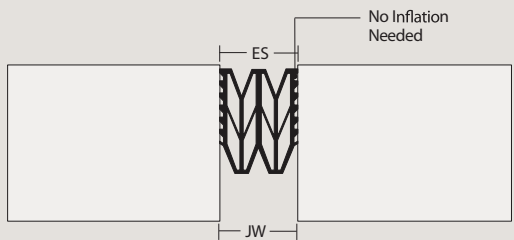

HB

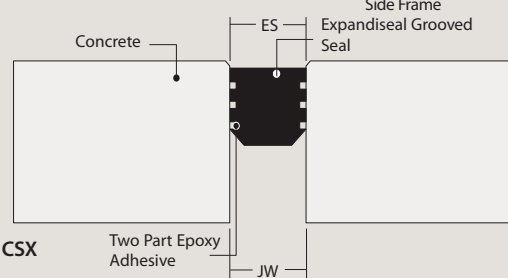

CSX

Model Data Floor to Floor Covers

JOINT WIDTH (JW)	19.0mm	25.0mm	32.0mm	38.0mm	44.0mm	51.0mm	60.0mm	67.0mm	76.0mm	100.0mm
MINIMUM OPENING	13.0mm	18.0mm	20.0mm	25.0mm	30.0mm	35.0mm	40.0mm	45.0mm	50.0mm	63.0mm
MAXIMUM OPENING	31.0mm	44.0mm	50.0mm	63.0mm	75.0mm	88.0mm	100.0mm	113.0mm	125.0mm	156.0mm
EXPOSED SURFACE (ES)	19.0mm	25.0mm	32.0mm	38.0mm	44.0mm	51.0mm	60.0mm	67.0mm	76.0mm	100.0mm
SPECIFY MODEL	CSX25	CSX35	CSX40	CSX50	CSX60	CSX70	CSX80	CSX90	CSX100	CSX125

Model Data Floor to Floor Covers

JOINT WIDTH (JW)	101.6mm	152.4mm	203.2mm	152.4mm	203.2mm	254.0mm	304.8mm	355.6mm	406.4mm
MINIMUM OPENING	50.8mm	50.8mm	76.2mm	0.0mm	0.0mm	0.0mm	0.0mm	0.0mm	0.0mm
MAXIMUM OPENING	165.1mm	241.3mm	317.5mm	279.4mm	330.2mm	406.4mm	482.6mm	558.8mm	635.0mm
EXPOSED SURFACE (ES)	285.8mm	412.8mm	514.4mm	498.6mm	549.4mm	625.6mm	695.5mm	771.7mm	847.9mm
SPECIFY MODEL	KB 400	KB 600	KB 800	PTC 600	PTC 800	PTC 1000	PTC 1200	PTC 1400	PTC 1600

Model Data Floor to Wall Covers

	101.6mm	152.4mm	203.2mm
MINIMUM OPENING	0.0mm	101.6mm	139.7mm
MAXIMUM OPENING	133.4mm	196.9mm	260.4mm
EXPOSED SURFACE (ES)	193.8mm	282.7mm	358.9mm
SPECIFY MODEL	KBW400	KBW600	KBW800

Model Data Floor to Floor Covers

JOINT WIDTH (JW)	25.4mm	50.8mm	76.2mm	101.6mm	25.4mm	50.8mm	76.2mm	101.6mm
MINIMUM OPENING	12.7mm	25.4mm	38.1mm	50.8mm	12.7mm	25.4mm	38.1mm	50.8mm
MAXIMUM OPENING	38.1mm	76.2mm	114.3mm	152.4mm	38.1mm	76.2mm	114.3mm	152.4mm
EXPOSED SURFACE (ES)	203.2mm	228.6mm	254.0mm	279.4mm	25.4mm	50.8mm	76.2mm	101.6mm
SPECIFY MODEL	ZB 100	ZB 200	ZB 300	ZB 400	HB 100	HB 200	HB 300	HB 400

No matter what joint cover you need, we've got the right fire and water barrier.



Hypalon[®]100mm - 450mm

The CS Hypalon is a synthetic rubber sheet designed to prevent liquids from infiltrating through movement joints in all building structures. CS Hypalon available in multiple widths to accommodate all your movement criteria including shear. Uses for CS Hypalon are, but not limited to, indoor and outdoor applications, parking structures, shopping centres, hospitals and airports



Promaseal[®]PLUS

Promaseal Plus is a specially designed, self supporting silicate board used for fire protection of expansion joints. Promaseal Plus is secured to the underside of your expansion joint and is custom made to fit your movement criteria and joint opening. Promaseal Plus offers a 2 hour fire rating and is chemically inert and is resistant to dilute acids and alkalis.



FireMaster[®] TTT[®]

The TTT fire rating system is an intumescent expanding felt that is supported by epoxy and optional steel plate for reinforcement. TTT has been designed to expand, up to 3 times its size, upon immediate contact with fire and heat to prevent fumes, fire and heat from travelling through your expansion joint. TTT has been fire rated for up to 2 hours according to approved installation.



Promaseal® Fyrestrip 15mm-65mm

Promaseal FyreStrip is a compressible, flexible, fire resistant seal to suit expansion joints in all areas of your building. It consists of layers of intumescent material bonded to a special foam and has been successfully fire tested for up to 4 hours in joints with masonry or concrete walls and concrete floors.



Grafitex® 30mm -100mm

Grafitex has been designed to be used as a single drape configuration held in the expansion joint by a perforated steel sheet for added support. Grafitex plus is an intumescent sheet that expands upon contact with heat and fire to prevent fumes, fire and heat from travelling through your expansion joint. Fire rated for up to 2 hours.



Multiflex® 75mm - 305mm

The Multiflex fire barrier is a sandwich like design consisting of multiple sheets inside a stainless steel foil and mesh. Multiflex is available in various sizes to accommodate all your floor and wall expansion joints and is multi directional including shear. Multiflex is mounted in the block out allowed for your expansion joint cover and has a 2 hour fire rating.



FireMaster 607® Blanket

Consists of a single drape configuration of stainless foil and insulation. Enhanced thermal and acoustic properties are provided through using a patented fibre formulation. Significant fire testing of the FireMaster 607 has resulted in a fire rating of four hours. Along with its superior design and physical properties, FireMaster 607 was designed to have zero effect on the human body when exposed.



Construction Specialties Australia Pty Ltd

PH: 1300 272 602
FAX: 1300 247 407

📍 www.c-sgroup.com.au

Construction Specialties NZ Ltd

PH: +(64) 9444 0238
FAX: +(64) 9444 0239

📍 www.cs-group.co.nz



The C/S Family of Products

For more than 60 years, Construction Specialties has been a leader in architectural specialty products, including: Acrovyn® Wall and Door Protection, Pedisystems® Entrance Flooring, Expansion Joint Covers, Cubicle Track and Curtains, Smoke and Explosion Venting Systems, Architectural Grilles, Architectural Louvers and Sun Controls.

We have operations throughout the world and can provide C/S Products virtually anywhere. For a complete list of our international locations, visit www.c-sgroup.com.au.

For the nearest C/S representative, or literature and samples, call 1300 272 602 AUS or visit www.c-sgroup.com.au

©Copyright 2010 Construction Specialties, Inc.

Construction Specialties, Inc. reserves the right to make design changes or to withdraw any design without notice. Printed in AUS. Series 01